

System

54 | 65 | 100 | 150 | 200

Modelos / Models



Sistemas de tubos luminosos | Tubular Lighting Systems



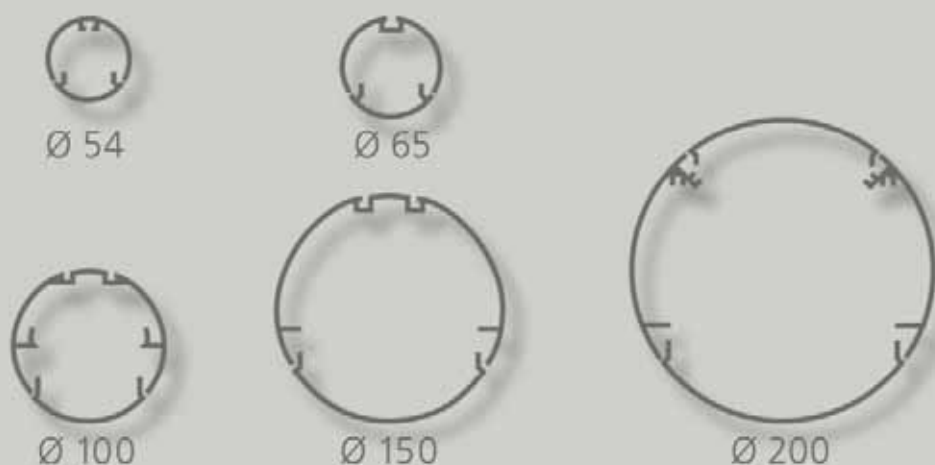

System

54 • 65 • 100
150 • 200

- Sistemas de tubos luminosos polifacéticos con diámetros de Ø 54 mm, Ø 65 mm, Ø 100 mm, Ø 150 mm y Ø 200 mm. Combina función y técnica en su forma ideal.

- Alumbrado económico von lámparas fluorescentes de Ø26 mm y Ø 16 mm, incluido balastro electrónico. Los elementos con portalámparas para las más diversas lámparas incandescentes o halógenas permiten multitud de variaciones.

- Material de aluminio y acero de gran rentabilidad.

- Respetamos el medio ambiente empleando materiales reciclables.

- Cableado pasante de 3 polos 1,5² para el sistema Ø 54 mm.

- Cableado pasante de 5 polos 1,5² para los sistemas de Ø 65 mm, Ø 100 mm, Ø 150 mm y 200 mm.

- The Ø 54 mm, Ø 65 mm, Ø 150 mm and Ø 200 mm diameter tubular lighting systems are an ideal link between function and technology.

- Economic lighting with Ø 26 mm and Ø 16 mm fluorescent lamps including electronic ballast. Modules with lamp holders for different bulbs or low voltage lamps allow innumerable combinations of interior design.

- 3 x 1,5² through-wiring with plug-in connectors for system Ø 54 mm.

- 5 x 1,5² through-wiring with plug-in connectors for systems Ø 65 mm, Ø 100 mm, Ø 150 mm and Ø 200 mm.

System 54

directaT26 direct T26

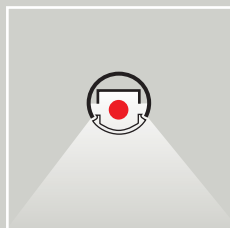

+ - 1 lámpara, balastro electrónico

- Cierre de vidrio acrílico
- Sistema de luminarias con brida
- Sin suspensión

- 1-lamp, electronic ballast

- Acrylic diffuser
- Luminaire with tube flanges
- without suspension

directaT16 direct T5

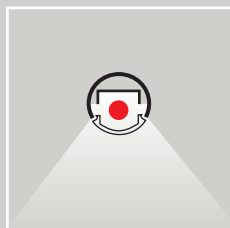

+ - 1 lámpara, balastro electrónico

- Cierre de vidrio acrílico
- Sistema de luminarias con brida
- Sin suspensión

- 1-lamp, electronic ballast

- Acrylic diffuser
- Luminaire with tube flanges
- without suspension

Lámpara Lamp	Longitud Length	Art. No. Art. No.
1 x 18W T26	1175 mm	54.055
1 x 30W T26	1480 mm	54.056
1 x 38W T26	1650 mm	54.057
1 x 36W T26	1800 mm	54.058
1 x 58W T26	2100 mm	54.059

Lámpara Lamp	Longitud Length	Art. No. Art. No.
1 x 24W T16	1175 mm	54.102944
1 x 39W T16	1480 mm	54.102945
1 x 54W T16	1800 mm	54.102946
1 x 49W T16	2100 mm	54.102947



System 54

Vidrio acrílico Acrylic diffuser

para luminaria
for lamp

Art. No.
Art. No.

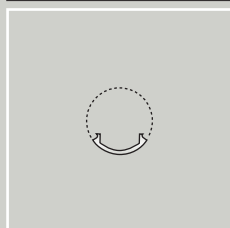

1 x 18W T26	54.065
1 x 30W T26	54.066
1 x 38W T26	54.067
1 x 36W T26	54.068
1 x 58W T26	54.069

- + - Con perfilado longitudinal
- with lengthwise prism

Placa terminal End plate

Art. No.
Art. No.

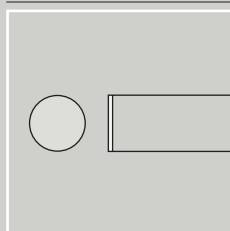

Placa terminal recta
Flat end plate

54.005

Elemento terminal End cap

Art. No.
Art. No.

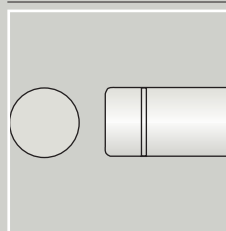

Rosca M4
Suspension thread M4

54.150

- + - Entrada de cables de Ø 38 mm, longitud 32 mm
- with cable entry hole, Ø 54, length 32 mm

Aplicación rail electrificado Track

Longitud hasta
Length max.

Art. No.
Art. No.

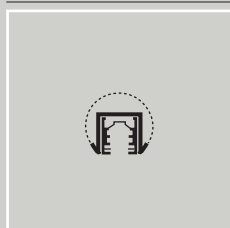

500 mm	54.303
1000 mm	54.304
2000 mm	54.305
3000 mm	54.306

- + - Rail electrificado trifásico (sin perfil vacío) 1 alimentador, 1 placa terminal
- 3-phase ERCO track (without empty tube), 1 live end, 1 dead end

Perfil vacío Empty tube

Art. No.
Art. No.

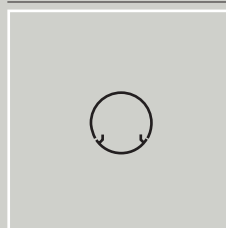

Perfil cerrado, bridas
Closed profile, flange

54.071

- para conexión o prolongación
- for connection or lengthening

- + - Longitud según especificación, máx. 2.500 mm.
- Length to be specified, max. 2500 mm

Portalámparas Holders

Portalámparas incorporado
Holder built-in

Art. No.
Art. No.

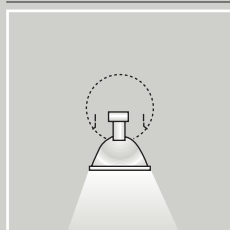

G 4	54.020
GU 5, 3	54.035
E 10	54.040
E 14	54.079

- + - Espacio necesario 100 mm
- Space required 100 mm

Fijación a la pared Wall fitting

(tubo no giratorio)
(Tube not revolving)

Art. No.
Art. No.

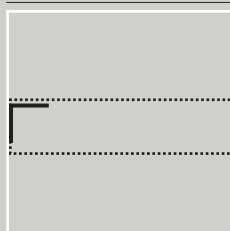

54.039

Fijación a la pared Wall fitting

(tubo giratorio)
(Tube revolving)

Art. No.
Art. No.

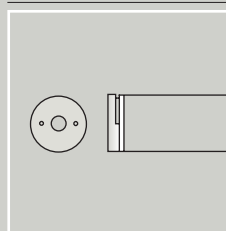

54.006

System 54

Conector angular Corner connector

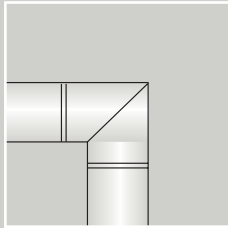

Art. No.	Art. No.
90°	54.077
60°	54.009
45°	54.014

- ⊕ - con rosca M4, entrada de cables
- with suspension thread M4, cable entry hole

Conector en T T-connector

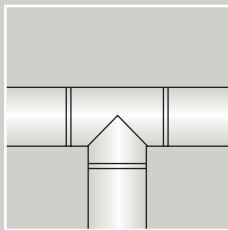

Art. No.	Art. No.
	54.036

- ⊕ - con rosca M4
- with suspension thread M4

Empalme Coupler

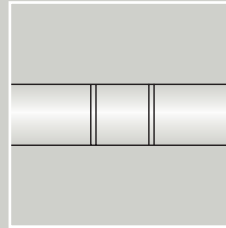

Art. No.	Art. No.
Ø 54, Länge 86 mm Ø 54, Length 86 mm	54.042
Ø 54, Länge 32 mm Ø 54, Length 32 mm	54.086

- ⊕ - con rosca M4
- with suspension thread M4

Conector en cruz Cross connector

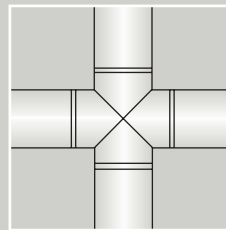

Art. No.	Art. No.
	54.078

- ⊕ - con rosca M4
- with suspension thread M4

Suspensión cable acero Steel wire suspension

Longitud Length	Art. No.	Art. No.
--------------------	----------	----------

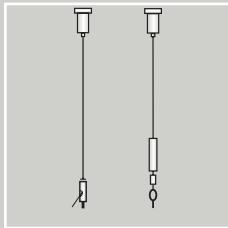

		Ajuste rápido sin necesidad de herramientas tool-less adjustability
500 mm	00.240	00.781
1000 mm	00.241	00.782
2000 mm	00.242	00.783

- ⊕ - para fijación al techo, anilla roscada M4
- for suspension on ceiling, threaded eye

Suspensión cable acero Steel wire suspension

Longitud Length	Art. No.	Art. No.
--------------------	----------	----------

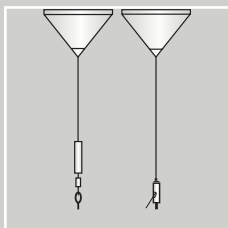

		Ajuste rápido sin necesidad de herramientas tool-less adjustability
500 mm	01.673	01.679
1000 mm	01.674	01.680
2000 mm	01.675	01.681

- ⊕ - Para gancho de techo, dosel blanco
- Steel wire suspension on ceiling hook, suspension cover, white

Tubo oscilante Ø 13 mm Rod suspension Ø 13 mm

Longitud Length	Art. No.	Art. No.
--------------------	----------	----------

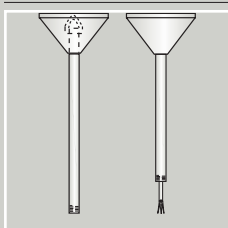

		con cable de conexión 3 x 1,5 ² with coiled supply cable 3 x 1,5 ²
500 mm	01.709	01.715
1000 mm	01.710	01.716
2000 mm	01.711	01.717

- ⊕ - Para gancho de techo, dosel blanco
- Suspension on ceiling hook, suspension cover, white

Cable conexión flexible Flexible cable

Color Colour	Longitud Length	Art. No.
-----------------	--------------------	----------

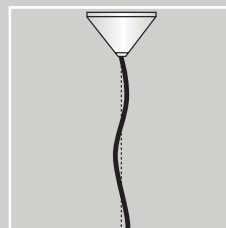

3 x 0,75 ² negro black	1000 mm	09.519
3 x 0,75 ² blanco white	1000 mm	09.520
3 x 1,0 ² negro black	2000 mm	09.521
3 x 1,0 ² blanco white	2000 mm	09.522

- ⊕ - 4 sujetacables de acero, dosel
- 4 steel wire clamps, suspension cover

Tubo oscilante Ø 13 mm Rod suspension Ø 13 mm

Longitud Length	Art. No.	Art. No.
--------------------	----------	----------

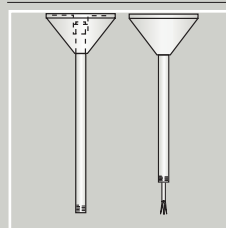

		con cable de conexión 3 x 1,5 ² with coiled supply cable 3 x 1,5 ²
500 mm	01.721	01.727
1000 mm	01.722	01.728
2000 mm	01.723	01.729

- ⊕ - Para la fijación al techo, dosel blanco
- for ceiling mounting, suspension cover white



System 54

Transformador Transformer

Art. No.
Art. No.

12V 50 VA con termofusible 12V 50 VA with thermal cut out	54.080
12V 100 VA con termofusible 12V 100 VA with thermal cut out	54.081
12V 105 VA electrónico 12V 105 VA electronic	54.121

✚ - Incorporado y cableado
- Fitted and wired

Balastro electrónico Electronic ballast

Art. No.
Art. No.

Art. No.
Art. No.

(regulable) técnica de control de 10 V (for dimming) Dimming 5 - 100% 10 V DC	5 - 100%	Tren de ondas Control Phase control dimming
✚ - regulable 230 V 50 Hz incorporado y cableado	1 x 36W T26 1 x 58W T26 1 x 39W T16 1 x 49W T16	09.366 09.368 09.526 09.529
✚ - Controllable ballast 230 V 50 Hz fitted and wired	1 x 54W T16 1 x 80W T16	09.530 09.531

Colores Colours

Nombre
Name

RAL





		amarillo melón melon yellow	1028
		rojo fuego fire red	3000
		azul blue	5010
		verde menta mint green	6029

✚ Consulte posibilidad de suministro en otros colores
Other colours available on request

Colores Colours

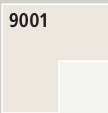
Nombre
Name

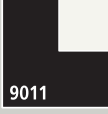
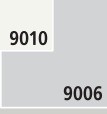
RAL

		blanco crema creme white	9001
		blanco grisáceo grey white	9002
		blanco puro pure white	9010
		negro grafito graphite black	9011
		plata silver	9006

✚ Consulte posibilidad de suministro en otros colores
Other colours available on request

System 65

directa T26 direct T26

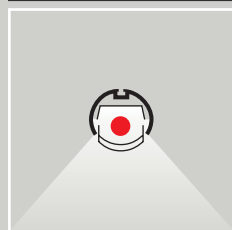

+ - 1 lámpara, balastro electrónico

- Módulo metálico blanco
- Sistema de luminarias con brida
- Sin suspensión

- 1-lamp, electronic ballast

- White crossbar louvre
- Luminaire with flange
- without suspension

Lámpara
Lamp

Longitud
Length

Art. No.
Art. No.

Art. No.
Art. No.

			sin ranura plain	con ranura grooved
1 x 18W T26	1175 mm	65.082	65.275	
1 x 30W T26	1480 mm	65.083	65.276	
1 x 38W T26	1725 mm	65.084	65.277	
1 x 36W T26	1800 mm	65.085	65.278	
1 x 58W T26	2112 mm	65.086	65.279	

directa T16 direct T5

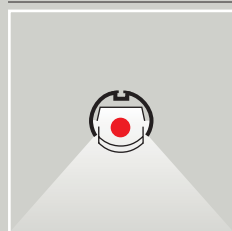

+ - 1 lámpara, balastro electrónico

- Módulo metálico blanco
- Sistema de luminarias con brida
- Sin suspensión

- 1-lamp, electronic ballast

- White crossbar louvre
- Luminaire with flange
- without suspension

Lámpara
Lamp

Longitud
Length

Art. No.
Art. No.

				con ranura grooved
1 x 24W T16	1175 mm		65.102932	
1 x 39W T16	1480 mm		65.102933	
1 x 54W T16	1800 mm		65.102934	
1 x 49W T16	2100 mm		65.102935	

directa T16 direct T5

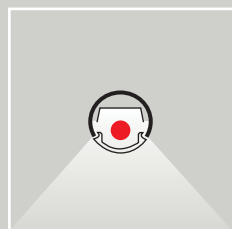

+ - 1 lámpara, balastro electrónico

- Cristal acrílico
- Sistema de luminarias con brida
- Sin suspensión

- 1-lamp, electronic ballast

- Acrylic diffuser
- Luminaire with flange
- without suspension

Lámpara
Lamp

Longitud
Length

Art. No.
Art. No.

			sin ranura plain	
1 x 24W T16	1175 mm	65.102936		
1 x 39W T16	1480 mm	65.102937		
1 x 54W T16	1800 mm	65.102938		
1 x 49W T26	2100 mm	65.102939		

directa T16 / IP65 direct T16 / IP65

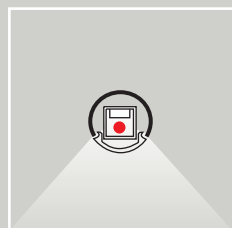

+ - 1 lámpara, balastro electrónico

- Aplicación de policarbonato
- Cierre de vidrio acrílico
- Lacado para exterior, brida
- Sin suspensión

- 1-lamp, electronic ballast

- Insert Polycarbonat
- Acrylic diffuser
- Weatherproof painted, flange
- without suspension

Lámpara
Lamp

Longitud
Length

Art. No.
Art. No.

			sin ranura plain	
1 x 14W T16	1200 mm	65.103506		
1 x 21W T16	1500 mm	65.103507		
1 x 28W T16	1800 mm	65.103508		
1 x 35W T16	2100 mm	65.103509		

System 65

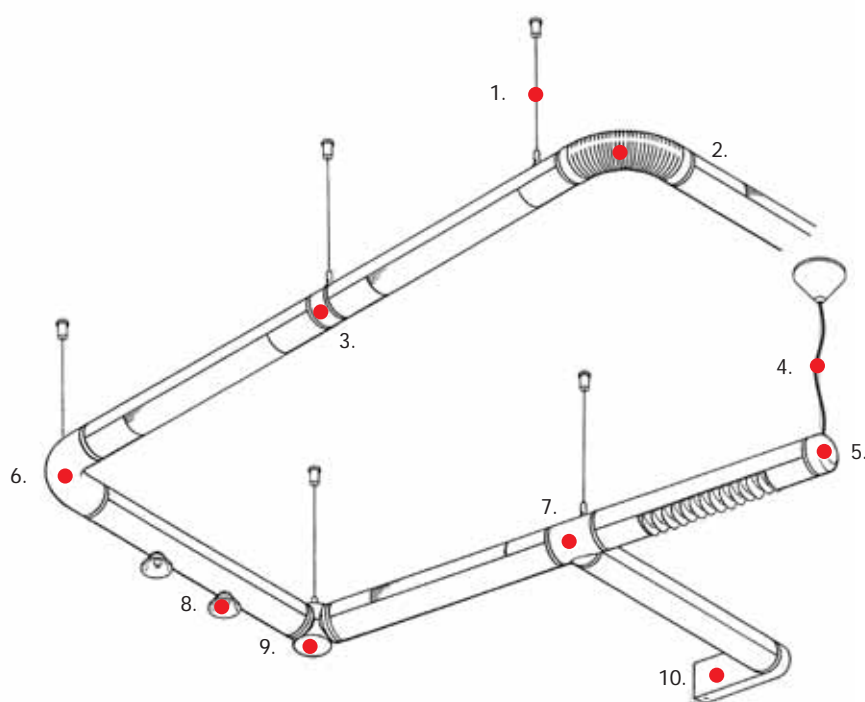

1. Suspensión de cable de acero	Steel wire suspension	20.11
2. Tubo flexible de metal	Flexible metal hose	20.10
3. Empalme	Coupler	20.10
4. Cable de conexión flexible	Flexible cable	20.11
5. Elemento terminal	End cap	20.9
6. Arco	Bend	20.10
7. Conector en T	T-connector	20.10
8. Portalámparas	Holder	20.9
9. Conector articulado	Joint connector	20.10
10. Brazo extensor	Wall bracket	20.11

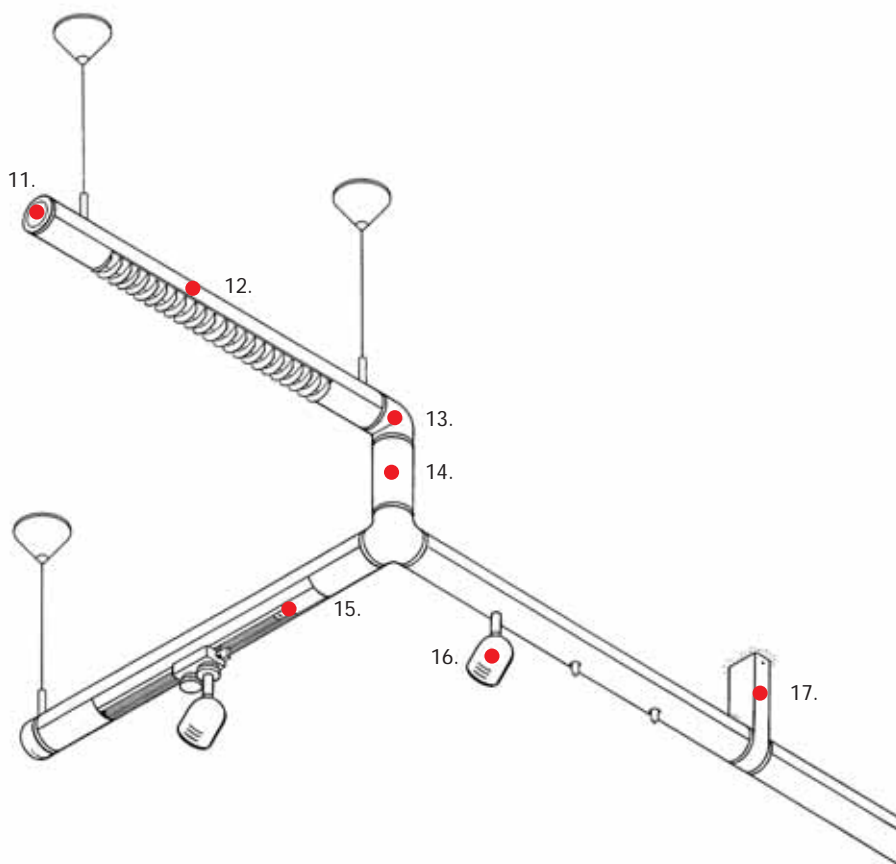

11. Placa terminal	End plate	20.9
12. Tubo luminoso con ranura	Tube with groove	20.7
13. Arco	Bend	20.10
14. Perfil vacío	Empty tube	20.9
15. Aplicación de rail electrificado	Conductor track	20.9
16. Proyector	Spot	20.9
17. Brazo extensor	Wall bracket	20.9

System 65

Cierre de vidrio acrílico Acrylic diffuser

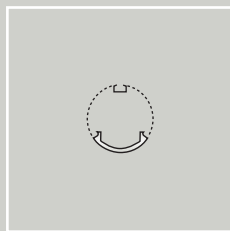

para luminaria for Lamp	Art. No. Art. No.
1 x 18W T26	65.438
1 x 30W T26	65.439
1 x 38W T26	65.440
1 x 36W T26	65.441
1 x 58W T26	65.442

- Con perfilado longitudinal
- with lengthwise prism

Placa terminal End plate

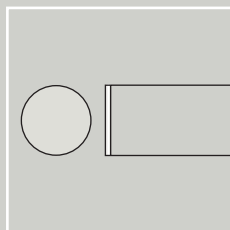

Placa terminal recta Flat end plate	Art. No. Art. No.
	65.136

Aplicación de rail electrificado Track

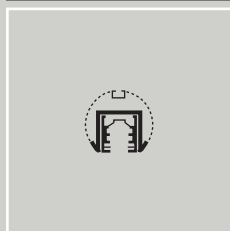

Longitud Max. Length max.	Art. No. Art. No.
500 mm	65.528
1000 mm	65.529
2000 mm	65.530
3000 mm	65.531

- Rail electrificado trifásico(sin perfil vacío), 1 alimentador
- 3-phase ERCO track (without empty tube), 1 live end, 1 dead end

Portalámparas Holders

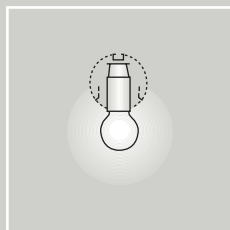

Portalámparas incorporado Holder built-in	Art. No. Art. No.
G 4	65.766
GY 6, 35	65.767
GU 5, 3	65.450
E 14	65.062

- Espacio necesario 100 mm
- Space required 100 mm

Pasador de suspensión Suspension slide

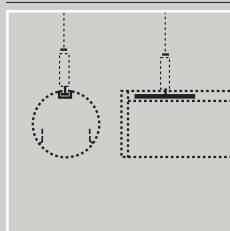

Rosca M4 Suspension thread M4	Art. No. Art. No.
	65.108

- Para tubos con ranura
- for tubes with groove

Elemento terminal End cap

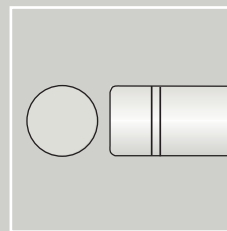

Rosca M4 Suspension thread M4	Art. No. Art. No.
	65.115

- Entrada de cables de Ø 65 mm, longitud 32 mm
- with cable entry hole, Ø 65, Length 32 mm

Perfil vacío Empty tube

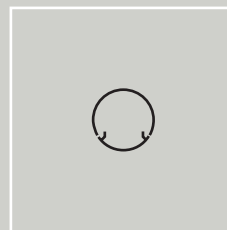

sin ranura plain	Art. No. Art. No.	con ranura grooved
Perfil cerrado Profile closed	65.011	65.569

- Longitud según especificación, máx. 2.500 mm, bridas
- Length to be specified, max. 2500 mm, tube flanges

Proyector de bajo voltaje Low voltage spotlight

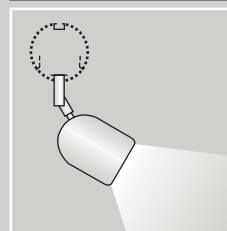

Art. No.
Art. No.

01.466

- Giratorio y orientable 12 V 50 W, sin transformador
- two-way adjustable 12V 50W, without transformer

Fijación de pared para tubo Wall fixing for tube

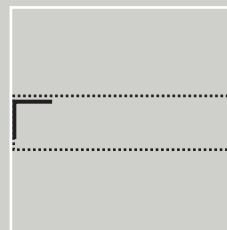

Fijación de pared y de techo para tubo	Art. No. Art. No.
Wall- and ceiling fixing for tube	65.026

Brazo extensor Wall bracket

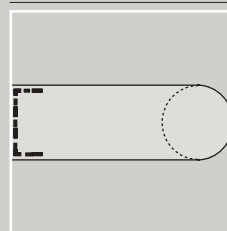

Montaje en línea, abierto Strip mounting, open	Art. No. Art. No.
	65.131

Montaje final, cerrado End mounting, closed	Art. No. Art. No.
	65.132

- Longitud 200 mm, anchura 25 mm
- Length 200 mm, width 25 mm



System 65

Conector angular Corner connector

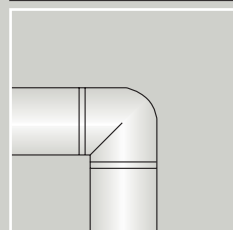

90°, Rosca M4	Art. No.
90°, Rosca M4	65.443
90°, Rosca M4 con entrada de cables	Art. No.
90°, suspension thread M4 with cable entry hole	65.396

Arco Bend

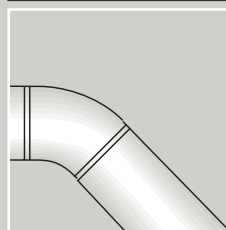

30°	Art. No.
30°	65.054
45°	Art. No.
45°	65.055
60°	Art. No.
60°	65.056

Conector en cruz Cross connector

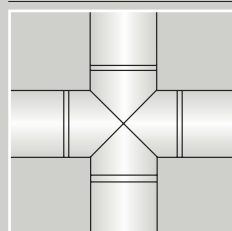

Rosca M4	Art. No.
Rosca M4	65.419
Suspension thread M4	

Conector en T T-connector

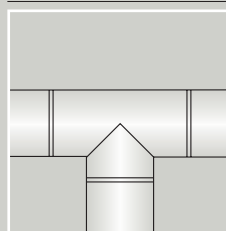

Rosca M4	Art. No.
Rosca M4	65.410
Suspension thread M4	

Empalme Coupler

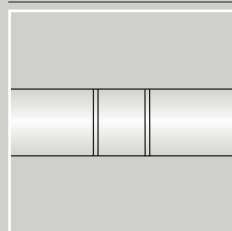

Ø 65, Longitud 32 mm	Art. No.
Ø 65, Longitud 32 mm	65.061
Ø 65, Longitud 75 mm	Art. No.
Ø 65, Longitud 75 mm	65.420

Conector angular 3 x 90° 3-way connector 3 x 90°

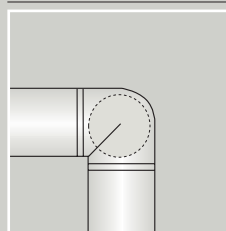

Rosca M4	Art. No.
Rosca M4	65.599
Suspension thread M4	

- + - Rosca M4, entrada de cables
- Suspension thread M4, cable entry hole

Conector 3 x 120° 3-way connector 3 x 120°

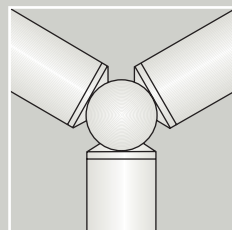

Rosca M4	Art. No.
Rosca M4	65.133
Suspension thread M4	

Conector 2 x 135°, 1 x 90° 3-way connector 2 x 135°, 1 x 90°

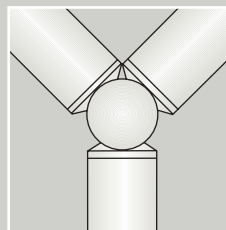

Rosca M4	Art. No.
Rosca M4	65.134
Suspension thread M4	

Conector articulado Joint connector

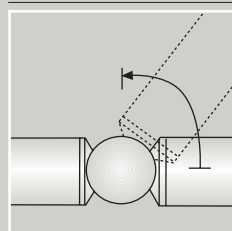

90° - 180°	Art. No.
90° - 180°	65.374

Tubo flexible de metal Flexible connector

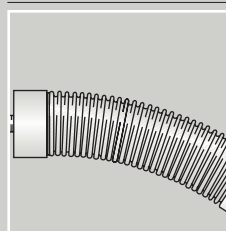

Longitud 250 mm	Art. No.
Longitud 250 mm	65.022
Longitud 500 mm	Art. No.
Longitud 500 mm	65.023

- + - Tubo flexible de metal de acero, si lo desea, puede disponer de otras longitudes
- Flexible stainless steel tube, other lengths deliverable on request

System 65

Suspensión cable acero Longitud Steel wire suspension Length

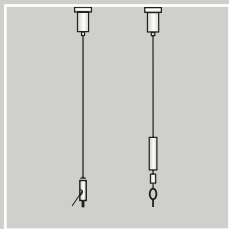

Longitud Length	Art. No. Art. No.	Art. No. Art. No.
500 mm	00.240	00.781
1000 mm	00.241	00.782
2000 mm	00.242	00.783

Ajuste rápido sin
necesidad de herramientas
tool-less
adjustable

- + Fijación al techo blanca
- Steel wire for suspension on ceiling, white

Cable conexión flexible Color Flexible cable Colour



Color Colour	Longitud Length	Art. No. Art. No.
3 x 0,75 ² negro black	1000 mm	09.519
3 x 0,75 ² blanco white	1000 mm	09.520
3 x 1,0 ² negro black	2000 mm	09.521
3 x 1,0 ² blanco white	2000 mm	09.522

- + 4 sujetacables de acero, dosel
- 4 steel wire clamps, suspension cover

Transformador Transformer

Art. No. Art. No.	
12V 50 VA con termofusible 12V 50 VA with thermal cut out	65.065
12V 100 VA con termofusible 12V 100 VA with thermal cut out	65.559
12V 105 VA electrónico 12V 105 VA electronic	65.572

- + Incorporado y cableado
- Fitted and wired

Colores Colours

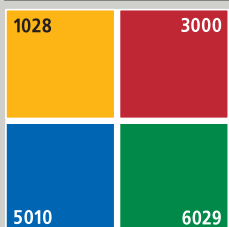

Nombre Name	RAL
amarillo melón melon yellow	1028
rojo fuego fire red	3000
azul blue	5010
verde menta mint green	6029

- + Consulte posibilidad de suministro en otros colores
- Other colours available on request

Suspensión cable acero Longitud Steel wire suspension Length

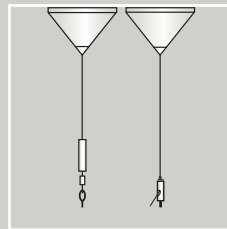

Longitud Length	Art. No. Art. No.	Art. No. Art. No.
500 mm	01.673	01.679
1000 mm	01.674	01.680
2000 mm	01.675	01.681

Ajuste rápido sin
necesidad de herramientas
tool-less
adjustable

- + Para gancho de techo, dosel blanco
- for suspension on ceiling hook, suspension cover, white

Balastro electrónico Electronic ballast

Art. No. Art. No.	Art. No. Art. No.
(regulable) técnica de control de 10 V (for dimming) Dimming 5 - 100% 10 V DC	Tren de ondas Control Phase control dimming
+ regulable 230 V 50 Hz incorporado y cableado	1 x 36W T26 09.366 1 x 58W T26 09.368 1 x 39W T16 09.526 1 x 49W T16 09.529 1 x 54W T16 09.530 1 x 80W T16 09.531
+ Controllable ballast 230 V 50 Hz fitted and wired	

Colores Colours

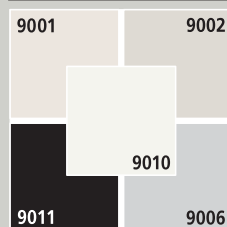

Nombre Name	RAL
blanco crema creme white	9001
blanco grisáceo grey white	9002
blanco puro pure white	9010
negro grafito graphite black	9011
plata silver	9006

- + Consulte posibilidad de suministro en otros colores
- Other colours available on request



System 54•65

Medida de eje y puntos de suspensión $\varnothing 54$ Dimensions & suspension points $\varnothing 54$

Conector angular
Corner connector

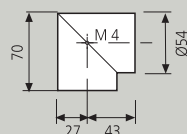

Conector angular
Corner connector

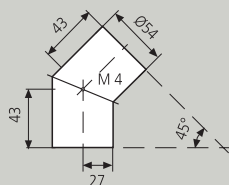

Conector angular
Corner connector

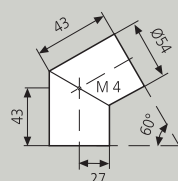

Elemento terminal
End cap

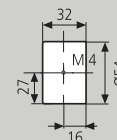

Conector en T
T-connector

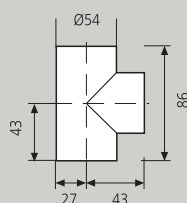

Conector en cruz
Cross connector

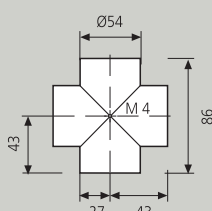

Empalme largo
Coupler long

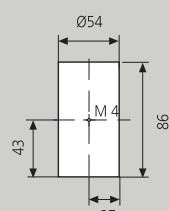

Empalme corto
Coupler short

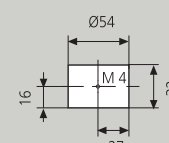

Medida de eje y puntos de suspensión $\varnothing 65$ Dimensions & suspension points $\varnothing 65$

Conector angular 90°
Corner connector 90°

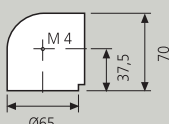

Arco 30°
Bend 30°

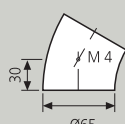

Arco 45°
Bend 45°

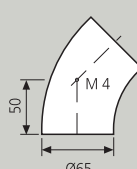

Arco 60°
Bend 60°

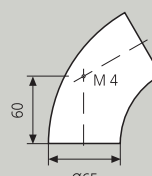

Conector articulado
Joint connector

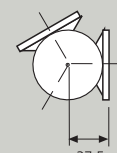

Conector en T
T-connector

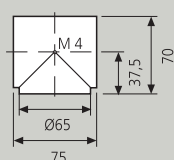

Conector en cruz
Cross connector

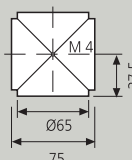

Empalme largo
Coupler long

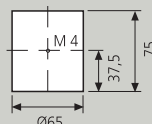

Empalme corto
Coupler short

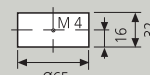

Elemento terminal
End cap

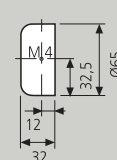

Conector triple 3 x 90°
3-way connector 3 x 90°

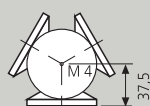

Conector triple
1 x 90° y 2 x 135°
3-way connector
1 x 90° and 2 x 135°

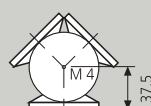

Brazo extensor
Wall bracket

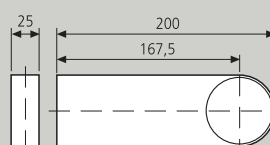

Brazo extensible
Wall bracket overlapping

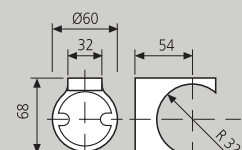

System 100

directa direct

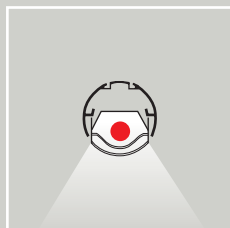

+ - 1 lámpara, balastro electrónico

- Módulo metálico blanco
- Brida
- Sin suspensión

- 1-lamp, electronic ballast

- White crossbar louvre
- Flange
- without suspension

Lámpara Lamp	Longitud Length	Art. No. Art. No.	Art. No. Art. No.
		sin ranura plain	con ranura grooved
1 x 36W TC-L	600 mm	100.414	100.419
1 x 18W T26	733 mm	100.005	100.405
1 x 30W T26	1033 mm	100.081	100.406
1 x 36W T26	1333 mm	100.007	100.408
1 x 58W T26	1633 mm	100.008	100.409

directa / indirecta direct / indirect

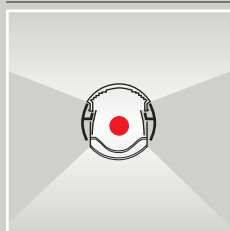

+ - 1 lámpara, balastro electrónico

- Módulo metálico blanco
- Bridas, vidrio acrílico arriba
- Sin suspensión
- Salida de luz arriba reducida

- 1-lamp, electronic ballast

- White crossbar louvre
- Flange, acrylic above
- without suspension
- Opening on upper side

Lámpara Lamp	Longitud Length	Art. No. Art. No.
1 x 18W T26	733 mm	100.185
1 x 30W T26	1033 mm	100.186
1 x 36W T26	1333 mm	100.188
1 x 58W T26	1633 mm	100.189

- También disponible con dos lámparas con distribución
- 2 lamps down/below available on request

directa IP 33 direct IP 33

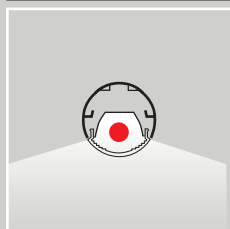

+ - 1 lámpara, balastro electrónico

- Vidrio acrílico sellado
- Lacado para exterior, brida
- Sin suspensión

- 1-lamp, electronic ballast

- Acrylic diffuser, sealing material
- Weatherproof painted, flange
- without suspension

Lámpara Lamp	Longitud Length	Art. No. Art. No.
		sin ranura plain
1 x 18W T26	733 mm	100.875
1 x 30W T26	1033 mm	100.876
1 x 36W T26	1333 mm	100.877
1 x 58W T26	1633 mm	100.878

directa IP 54 direct IP 54

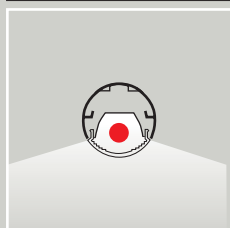

+ - 1 lámpara, balastro electrónico

- Vidrio acrílico sellado
- Lacado para exterior
- Bridas selladas
- Sin suspensión
- Portalámparas resistentes al polvo y al agua

- 1-lamp, electronic ballast

- Acrylic diffuser, sealing material
- Weatherproof painted, flange
- Lampholders dustproof and watertight
- without suspension

Lámpara Lamp	Longitud Length	Art. No. Art. No.
		sin ranura plain
1 x 18W T26	833 mm	100.1188
1 x 30W T26	1133 mm	100.1189
1 x 36W T26	1433 mm	100.1190
1 x 58W T26	1733 mm	100.1191

System 100

Cierre de vidrio acrílico Acrylic diffuser

para luminaria
for Lamp

Art. No.
Art. No.

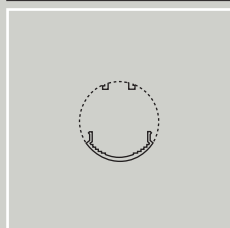

1 x 18W T26	100.050
1 x 30W T26	100.082
1 x 36W T26	100.052
1 x 58W T26	100.053

- + - Con prismas longitudinales
- with lengthwise prism

Elemento terminal Tube end

Ø 100 x 42 mm, M4

Art. No.
Art. No.

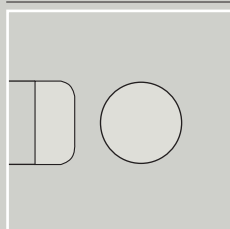

100.031

Perfil vacío Empty tube

Art. No.
Art. No.

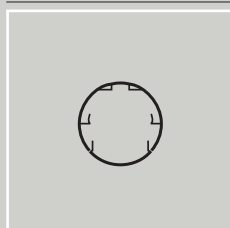

Perfil dos piezas sin ranura Profile 1/3 + 2/3 plain	100.228
Perfil dos piezas con ranura Profile 1/3 + 2/3 grooved	100.792

- + - Longitud según especificación, sin brida
- Length to be specified, without flange

Proyector Recessed downlight

Art. No.
Art. No.

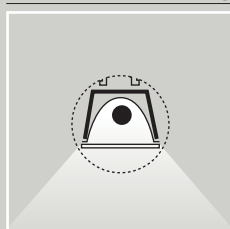

Balastro	HQI-TS 70W	100.389
convencional/	SDW-T 100W	100.1586
magnético	CDM-T 70W	100.1603
ballast		

- + - Filtro de bloqueo, espacio necesario 600 mm (sin tubo calibrador)
- Safety glass, space required 600 mm (without empty tube)

Fijación a la pared Wall bracket

Art. No.
Art. No.

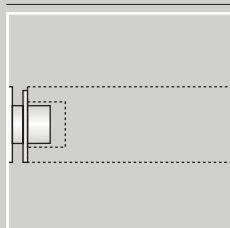

Tubos luminosos directos for use light-tube direct	100.229
Tubos luminosos directos/indirectos for use light-tube direct/indirect	100.271

- + - Fijación a la pared y al techo para tubo ± 8 mm
- Wall and ceiling connector ± 8 mm adjustment

Placa terminal End plate

Art. No.
Art. No.

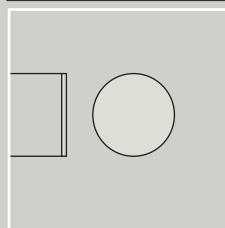

Placa terminal recta
Flat end plate

100.065

Aplicación rail electrificado Track

Longitud max.
Length max.

Art. No.
Art. No.

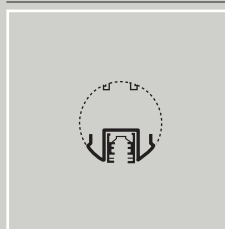

500 mm	100.756
1000 mm	100.757
2000 mm	100.758
3000 mm	100.759

- + - Rail electrificado trifásico(sin perfil vacío), alimentador, placa terminal
- 3-phase ERCO track (without empty tube), 1 live end, 1 dead end

Portalámparas Holders

Portalámparas incorporado
Holder built-in

Art. No.
Art. No.

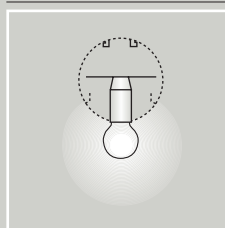

G 4	100.934
GY 6, 35	100.1185
GU 5, 3	100.676
E 14	100.362
E 27	100.379

- + - Espacio necesario 100 mm
- Space required 100 mm

Fijación a la pared Wall connector

Art. No.
Art. No.

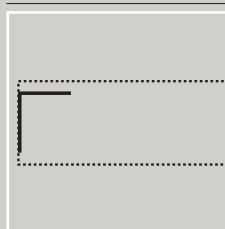

Fijación a la pared y al techo para tubo

Wall and ceiling connector for tube

100.059

Fijación a la pared y al techo Wall and ceiling connector

Art. No.
Art. No.

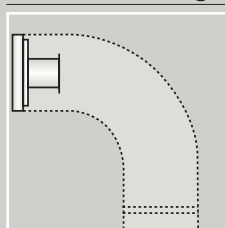

para arco R=185
for Bend R=185

para arco R=115
for Bend R=115

100.196

100.1587

- + - Fijación a la pared y al techo
- Wall and ceiling connector

System 100

Conector angular Corner connector

Art. No.
Art. No.

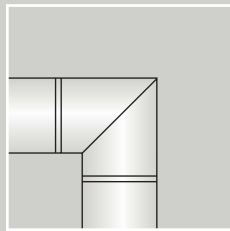

90°

100.373

- ⊢ - Rosca M4
- Suspension thread M4

Conector en cruz Cross connector

Art. No.
Art. No.

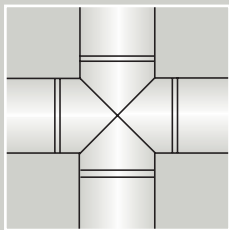

100.116

- ⊢ - Rosca M4
- Suspension thread M4

Arco Bend

Art. No.
Art. No.

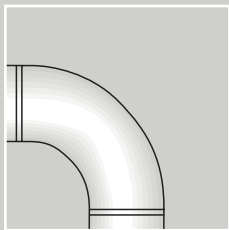

Arco, Bend 90°, R=185

100.026

Arco, Bend 90°,
entrada de cables
Cable entry hole

100.126

Arco, Bend 30°

100.060

Arco, Bend 45°

100.061

Arco, Bend 60°

100.062

- ⊢ - Rosca M4
- Suspension thread M4

Conector articulado Joint connector

Art. No.
Art. No.

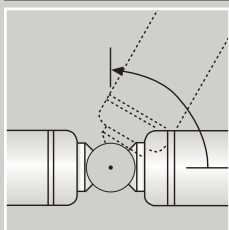
Rosca M4,
ajustable a 90° - 180°

100.195

Suspension thread M4,
90 - 180° adjustable

Brazo extensor Wall bracket

Art. No.
Art. No.

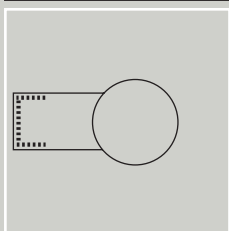
montaje en línea, abierto
one opening

100.230

montaje en línea, cerrado
two openings

100.232

- ⊢ - Alcance total 185 mm, fijación de pared oculta
- Total projection 185 mm, covered wall bracket

Conector en T T-connector

Art. No.
Art. No.

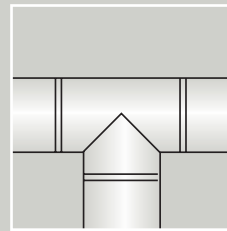

100.115

- ⊢ - Rosca M4
- Suspension thread M4

Arco Bend

Art. No.
Art. No.

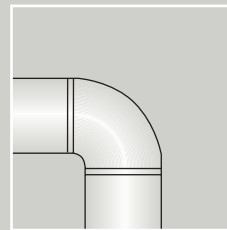

90°, R=115

100.111

90°, R=115,
entrada de cables
Cable entry hole

100.134

- ⊢ - Rosca M4
- Suspension thread M4

Empalme Coupler

Art. No.
Art. No.

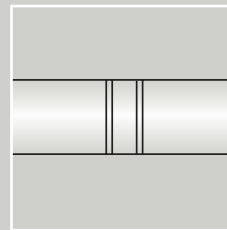
Rosca M4,
entrada de cables
Suspension thread M4,
Cable entry hole

100.110

- ⊢ - Ø 100 x 32 mm

Tubo flexible de metal Flexible metal hose

Art. No.
Art. No.

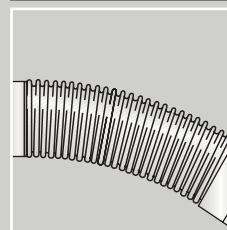
Longitud 250 mm
Length 250 mm

100.201

Longitud 500 mm
Length 500 mm

100.027

- ⊢ - Acero fino
- Stainless steel

Brazo extensor Wall bracket

Art. No.
Art. No.

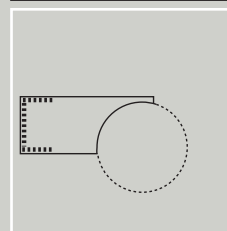
extensible
overlapping

100.891

- ⊢ - Alcance total 185 mm, fijación de pared oculta
- Total projection 185 mm, covered wall bracket

System 100

Brazo extensor con pie Wall bracket with adjustment

Art. No.
Art. No.

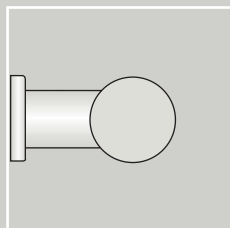

montaje en línea, abierto
one opening **100.030**

montaje en línea, cerrado
one opening **100.131**

- + - Alcance total 200 mm
- Lateral and forward adjustment, total projection 200 mm

Pasador de suspensión Sliding suspension

Art. No.
Art. No.

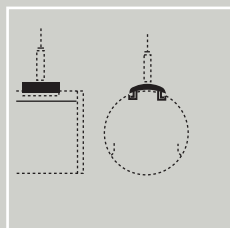

Rosca M4 **100.033**
Suspension thread M4

- + - Para tubos con ranura
- for grooved tubes

Transformador Transformer

Art. No.
Art. No.

12V 50 VA con termofusible **100.448**
12V 50 VA with thermal cut out

12V 100 VA con termofusible **100.449**
12V 100 VA with thermal cut out

12V 105 VA electrónico **100.787**
12V 105 VA electronic

- + - Incorporado y cableado
- Fitted and wired

Suspensión cable acero Steel wire suspension

Longitud
Length **Art. No.** **Art. No.**

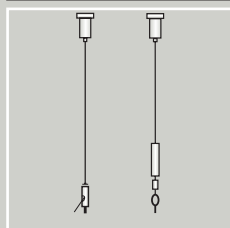

Ajuste rápido sin
necesidad de herramientas
tool-less
adjustable

500 mm **00.240** **00.781**

1000 mm **00.241** **00.782**

2000 mm **00.242** **00.783**

- + - Fijación al techo blanca
- for suspension on ceiling, white

Suspensión cable acero Steel wire suspension

Longitud
Length **Art. No.** **Art. No.**

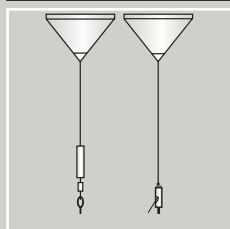

Ajuste rápido sin
necesidad de herramientas
tool-less
adjustable

500 mm **01.673** **01.679**

1000 mm **01.674** **01.680**

2000 mm **01.675** **01.681**

- + - Para gancho de techo, dosel blanco
- for suspension on ceiling hook, suspension cover, white

Brazo extensor con pie Wall bracket with adjustment

Art. No.
Art. No.

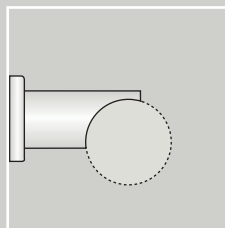

extensible **100.741**
overlapping

- + - Alcance total 200 mm
- Lateral and forward adjustment, total projection 200 mm

Cable conexión flexible Flexible cable

Color
Colour Longitud
Length **Art. No.** **Art. No.**



3 x 0,75² negro 1000 mm **09.519**
black

3 x 0,75² blanco 1000 mm **09.520**
white

3 x 1,0² negro 2000 mm **09.521**
black

3 x 1,0² blanco 2000 mm **09.522**
white

- + - 4 sujetacables de acero, dosel
- 4 steel wire clamps, suspension cover

System

100 • 150 • 200

1. Cable de conexión flexible Flexible cable	20.16
2. Placa terminal End plate	20.14
3. Conector angular Corner connector	20.15
4. Proyector Spotlight	21.1
5. Perfil vacío Empty tube	20.14
6. Conector en T T-connector	20.15
7. Portalámparas G4 Holder G4	20.14
8. Tubo flexible de metal Flexible metal hose	20.15
9. Suspensión de cable de acero Steel wire suspension	20.16
10. Empalme Coupler	20.15
11. Arco Bend	20.15
12. Elemento terminal Tube end	20.14
13. Aplicación de rail electrificado Conductor track	20.14
14. Proyector Spotlight	21.1
15. Conector articulado Joint connector	20.15
16. Brazo extensor Wall bracket	20.15
17. Fijación a la pared con compensación longitudinal Wall bracket with length adjustment	20.14

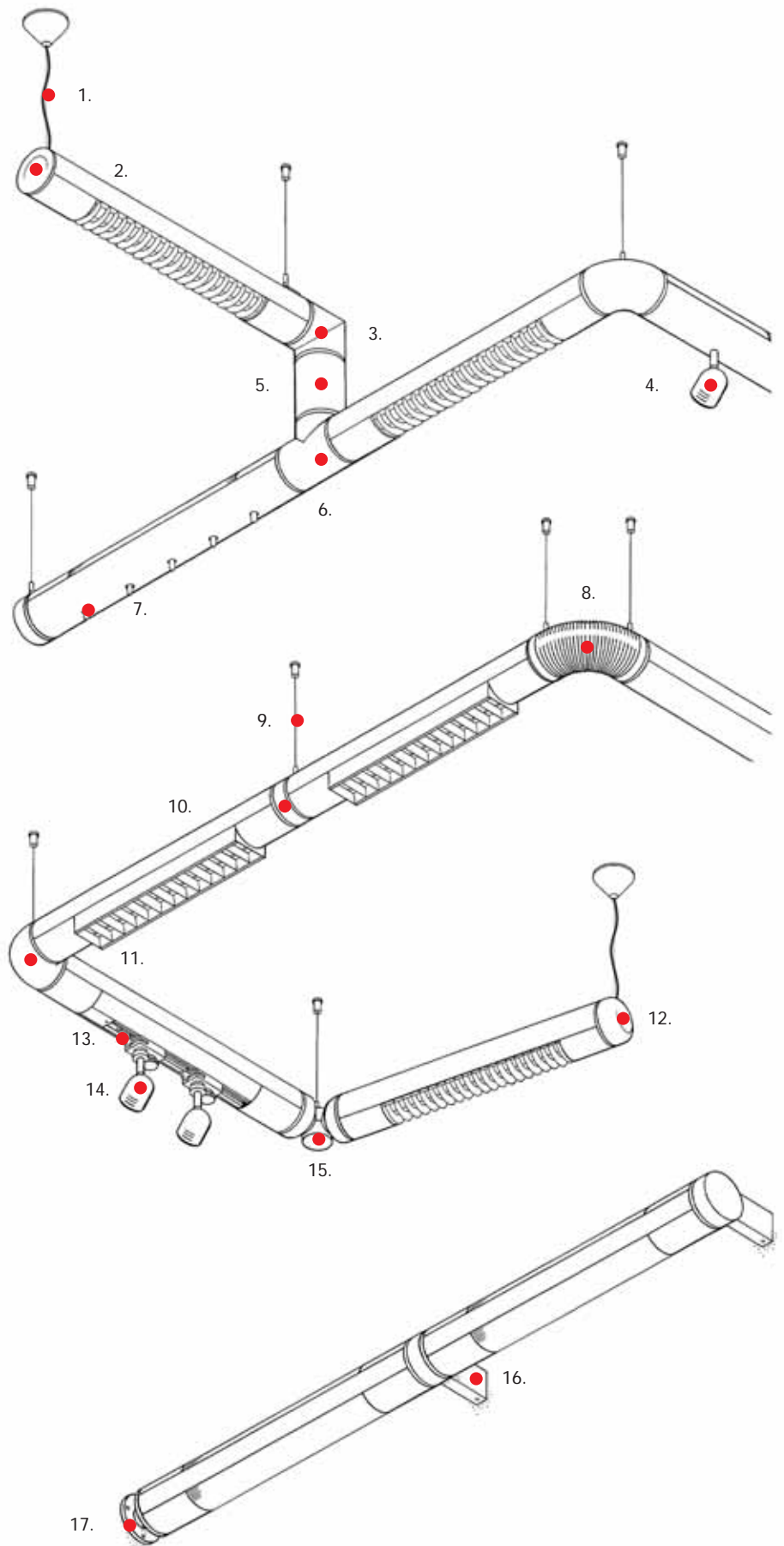

System 100

Medida de eje y puntos de suspensión Dimensions & suspension points

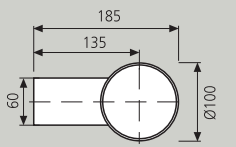

Brazo extensor sin pie
Wall bracket less foot

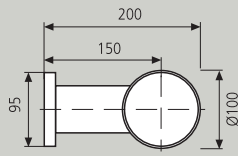

Brazo extensor con pie
Wall bracket with foot

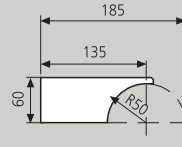

Brazo extensor extensible sin pie
Wall bracket overlapping less foot

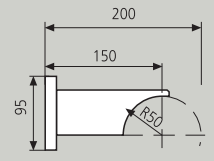

Brazo extensor extensible con pie
Wall bracket overlapping with foot

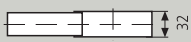

Conector en T
T-connector



Conector en cruz
Cross-connector



Conector angular 90°
Corner-connector 90°



Arco 90° pequeño
Bend 90° small

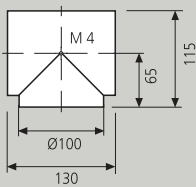

Arco 30°
Bend 30°

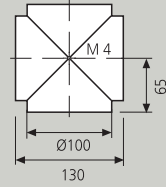

Arco 45°
Bend 45°

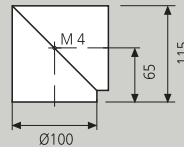

Arco 60°
Bend 60°

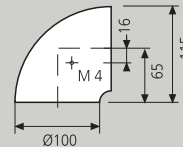

Empalme
Coupler

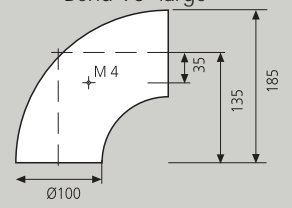

Arco 90° grande
Bend 90° large

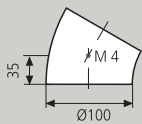

Conector triple
3 x 120°
3-way connector
3 x 120°

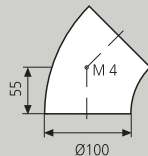

Conector triple
1 x 90° - 2 x 135°
3-way connector
1 x 90° - 2 x 135°

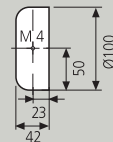
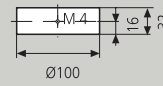
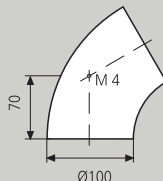

Elemento terminal
Tube end

Curvas de distribución lumínicas \pm cd / 1000 lm Light distribution curves

1-lámpara T26 / 1-lamp T8

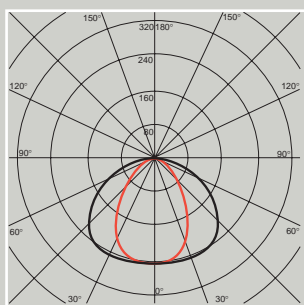

■ C 90.0/270.0 $\tau_{LB} = 69\%$ ■ C 0.0/180.0

1-lámpara T26 / 1-lamp T8

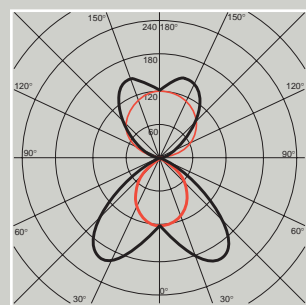

■ C 90.0/270.0 $\tau_{LB} = 79\%$ ■ C 0.0/180.0

System 150

directa / indirecta
direct / indirect

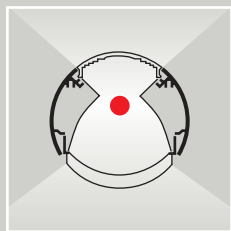

† - 1 lámpara, balastro electrónico

- Módulo metálico blanco
- Bridas
- Vidrio acrílico arriba
- Sin suspensión
- Salida de luz arriba reducida

- 1-lamp, electronic ballast

- White crossbar louvre
- Flange
- Acrylic diffuser above
- without suspension
- Shortened opening above

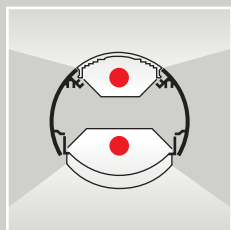

† - 2 lámparas, balastro electrónico

- Módulo metálico blanco
- Bridas
- Vidrio acrílico arriba
- Sin suspensión
- Distribución

- 2-lamps, electronic ballast

- White crossbar louvre
- Flange
- Acrylic diffuser above
- without suspension
- Separating ridge

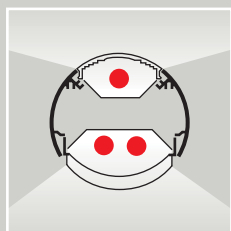

† - 3 lámparas, balastro electrónico

- Módulo metálico blanco
- Bridas
- Vidrio acrílico arriba
- Sin suspensión
- Distribución

- 3-lamps, electronic ballast

- White crossbar louvre
- Flange
- Acrylic diffuser above
- without suspension
- Separating ridge

directa
direct

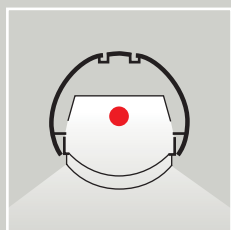

† - 1 lámpara, balastro electrónico

- Módulo metálico blanco
- Bridas
- Vidrio acrílico arriba
- Sin suspensión
- Distribución

- 1-lamp, electronic ballast

- White crossbar louvre
- Flange
- Acrylic diffuser above
- without suspension
- Separating ridge

directa
direct

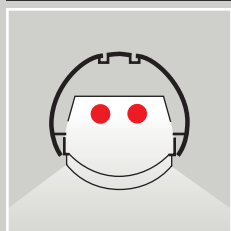

† - 2 lámparas, balastro electrónico

- Módulo metálico blanco
- Bridas
- Sin suspensión

- 2-lamps, electronic ballast

- White crossbar louvre
- Flange
- without suspension

Lámpara Lamp	Longitud Length	Art. No. Art. No.	Art. No. Art. No.
1 x 30W T26	1033 mm	150.106	
1 x 38W T26	1183 mm	150.107	
1 x 36W T26	1333 mm	150.108	
1 x 58W T26	1633 mm	150.109	
Lámpara Lamp	Longitud Length	Art. No. Art. No.	Art. No. Art. No.
2 x 30W T26	1033 mm	150.270	
2 x 38W T26	1183 mm	150.271	
2 x 36W T26	1333 mm	150.272	
2 x 58W T26	1633 mm	150.273	
Lámpara Lamp	Longitud Length	Art. No. Art. No.	Art. No. Art. No.
3 x 30W T26	1033 mm	150.772	
3 x 38W T26	1183 mm	150.773	
3 x 36W T26	1333 mm	150.774	
3 x 58W T26	1633 mm	150.775	
Lámpara Lamp	Longitud Length	Art. No. Art. No.	Art. No. Art. No.
1 x 18W T26	733 mm	150.002	sin ranura plain con ranura grooved
1 x 30W T26	1033 mm	150.003	150.325
1 x 38W T26	1183 mm	150.004	150.326
1 x 36W T26	1333 mm	150.005	150.327
1 x 58W T26	1633 mm	150.006	150.328
Lámpara Lamp	Longitud Length	Art. No. Art. No.	Art. No. Art. No.
2 x 18W T26	733 mm	150.095	ohne Nut plain mit Nut grooved
2 x 30W T26	1033 mm	150.096	150.330
2 x 38W T26	1183 mm	150.097	150.331
2 x 36W T26	1333 mm	150.098	150.332
2 x 58W T26	1633 mm	150.099	150.333

System 150

directa direct

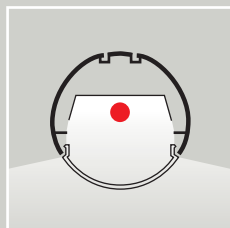

- + - 1 lámpara, balastro electrónico**
- Vidrio acrílico
- Bridas
- Sin suspensión
- 1-lamp, electronic ballast**
- Acrylic diffuser
- Flange
- without suspension

Lámpara Lamp	Longitud Length	Art. No. Art. No.	Art. No. Art. No.
		sin ranura plain	con ranura grooved
1 x 18W T26	733 mm	150.007	150.334
1 x 30W T26	1033 mm	150.008	150.335
1 x 36W T26	1333 mm	150.010	150.337
1 x 58W T26	1633 mm	150.011	150.338

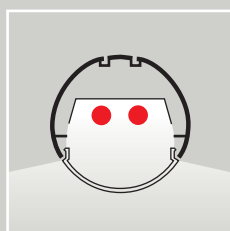

- + - 2 lámparas, balastro electrónico**
- Vidrio acrílico
- Bridas
- Sin suspensión
- 2-lamps, electronic ballast**
- Acrylic diffuser
- Flange
- without suspension

Lámpara Lamp	Longitud Length	Art. No. Art. No.	Art. No. Art. No.
		sin ranura plain	con ranura grooved
2 x 18W T26	733 mm	150.100	150.339
2 x 30W T26	1033 mm	150.101	150.340
2 x 36W T26	1333 mm	150.103	150.342
2 x 58W T26	1633 mm	150.104	150.343

directa IP 33 direct IP 33

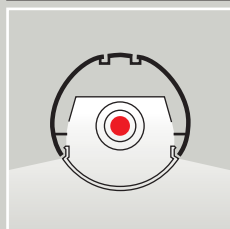

- + - 1 lámpara, balastro electrónico**
- Vidrio acrílico
- Lacado para exterior
- Bridas
- Sin suspensión
- 1-lamp, electronic ballast**
- Acrylic diffuser
- Painted for outdoor use
- Flange
- without suspension

Lámpara Lamp	Longitud Length	Art. No. Art. No.	Art. No. Art. No.
		sin ranura plain	
1 x 18W T26	733 mm	150.664	
1 x 30W T26	1033 mm	150.665	
1 x 36W T26	1333 mm	150.666	
1 x 58W T26	1633 mm	150.667	

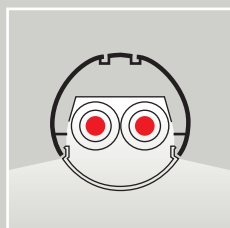

- + - 2 lámparas, balastro electrónico**
- Vidrio acrílico
- Lacado para exterior
- Bridas
- Sin suspensión
- 2-lamps, electronic ballast**
- Acrylic diffuser
- Painted for outdoor use
- Flange
- without suspension

Lámpara Lamp	Longitud Length	Art. No. Art. No.	Art. No. Art. No.
		sin ranura plain	
2 x 18W T26	733 mm	150.668	
2 x 30W T26	1033 mm	150.669	
2 x 36W T26	1333 mm	150.670	
2 x 58W T26	1633 mm	150.671	

directa IP 55 direct IP 55

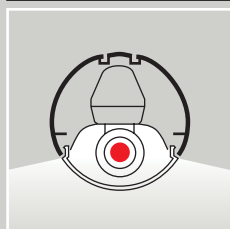

- + - 1 lámpara, balastro electrónico**
- Vidrio acrílico
- Lacado para exterior
- Bridas
- Sin suspensión
- 1-lamp, electronic ballast**
- Acrylic diffuser
- Painted for outdoor use
- Flange
- without suspension

Lámpara Lamp	Longitud Length	Art. No. Art. No.	Art. No. Art. No.
		sin ranura plain	
1 x 18W T26	733 mm	150.295	
1 x 36W T26	1033 mm	150.298	
1 x 58W T26	1633 mm	150.299	

System 150

Cierre de vidrio acrílico Acrylic diffuser

para luminarias
for Lamp

Art. No.
Art. No.

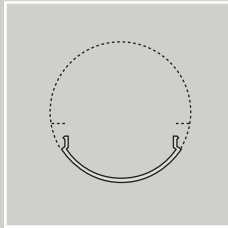

1 x 18W T26	150.190
1 x 30W T26	150.191
1 x 36W T26	150.192
1 x 58W T26	150.236

⊢ - Con perfilado longitudinal
- with lengthwise prism

Placa terminal End plate

Art. No.
Art. No.

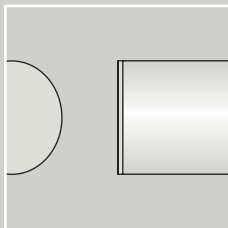

Placa terminal recta
Flat end plate

150.015

Cierre vidrio acrílico abierto Acrylic diffuser above

para luminaria
for Lamp

Art. No.
Art. No.

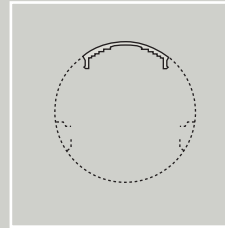

1 x 18W T26	150.240
1 x 30W T26	150.241
1 x 36W T26	150.243
1 x 58W T26	150.244

⊢ - Con perfilado longitudinal
- with lengthwise prism

Elemento terminal Tube end

Art. No.
Art. No.

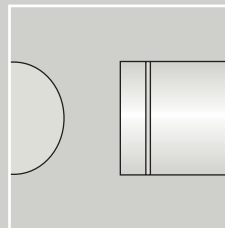

∅ 150 x 36 mm, M4
entrada de cable

150.552

∅ 150 x 36 mm, M4
cable entry hole

Aplicación rail electrificado Track

Longitud max.
Length max.

Art. No.
Art. No.

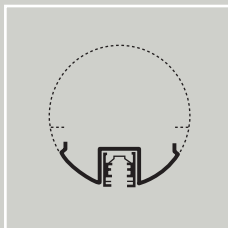

500 mm	150.466
1000 mm	150.467
2000 mm	150.468
3000 mm	150.469

⊢ - Rail electrificado trifásico (sin perfil vacío), alimentador, placa terminal
- 3-phase ERCO track (without empty tube), 1 live end, 1 dead end

Portalámparas Holders

Portalámparas incorporado
Holder built-in

Art. No.
Art. No.

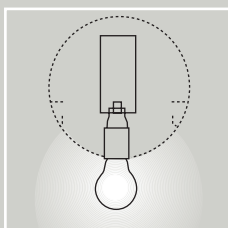

G 4	150.761
GY 6, 35	150.762
GU 5, 3	150.763
E 14	150.764
E 27	150.765

⊢ - Espacio necesario 100 mm
- Space required 100 mm

Perfil vacío Empty tube

Art. No.
Art. No.

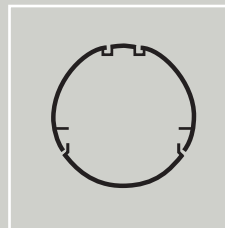

Perfil dos piezas sin ranura
2-part profile plain

150.250

Perfil dos piezas con ranura
2-part profile grooved

150.249

⊢ - Longitud según especificación, sin brida
- Length to be specified, without flange

Proyector Recessed downlight

Art. No.
Art. No.

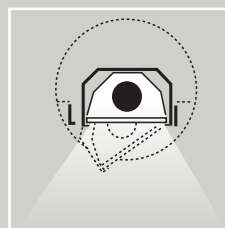

Balastro	HQI-TS 70W	150.359
convencional/	HQI-TS 150W	150.394
magnético	SDW-T 100W	150.766
ballast		

⊢ - Filtro de bloqueo, espacio necesario 600 mm (sin perfil vacío)
- Safety glass, space required 600 mm (without empty tube)

System 150

Conector en T T-connector

Art. No.
Art. No.

150.039

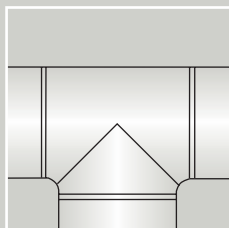

- + Rosca M4
- Suspension thread M4

Arco Bend

Art. No.
Art. No.

90° 150.013
45° 150.014

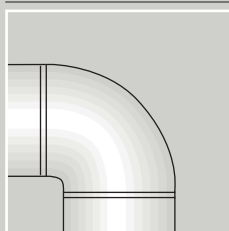

- + Rosca M4
- Suspension thread M4

Tubo flexible de metal Flexible metal hose

Art. No.
Art. No.

Longitud 500 mm
Length 500 mm

150.217

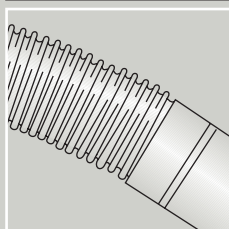

- + Acero fino
- Stainless steel

Pasador de suspensión Sliding suspension

Art. No.
Art. No.

100.033

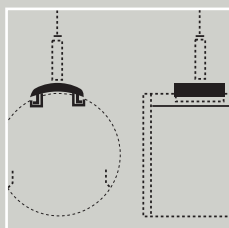

- + Rosca M4
- Suspension thread M4

Tubo oscilante Ø 13 mm Rod suspension Ø 13 mm

Longitud
Length

Art. No. Art. No.
Art. No. Art. No.

con cable de conexión
3 x 1,5²
with coiled supply
cable 3 x 1,5²

500 mm 01.709 01.715
1000 mm 01.710 01.716
2000 mm 01.711 01.717

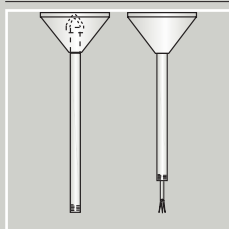

- + Para gancho de techo, dosel blanco
- Suspension on ceiling hook, suspension cover, white

Conector en cruz Cross connector

Art. No.
Art. No.

150.040

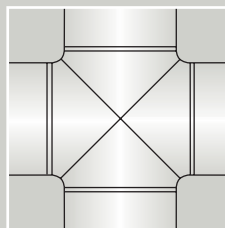

- + Rosca M4
- Suspension thread M4

Empalme Coupler

Art. No.
Art. No.

150.021

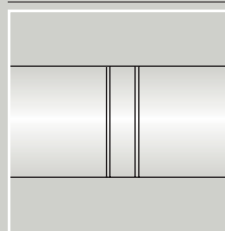

- Rosca M4,
entrada de cables
- Suspension thread M4,
cable entry hole

- + - Ø 150 x 32 mm

Brazo extensor con pie Wall bracket with adjustment

Art. No.
Art. No.

montaje en línea, abierto
two openings

150.245

montaje final, cerrado
one opening

150.246

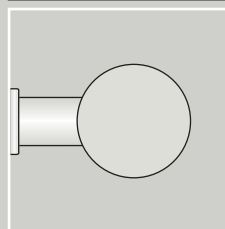

- + Alcance total 240 mm
- Total projection 240 mm

Transformador Transformer

Art. No.
Art. No.

12V 50 VA con termofusible
12V 50 VA with thermal cut out

150.767

12V 100 VA con termofusible
12V 100 VA with thermal cut out

150.768

12V 105 VA electrónico
12V 105 VA electronic

150.769

- + Incorporado y cableado
- Fitted and wired

Tubo oscilante Ø 13 mm Rod suspension Ø 13 mm

Longitud
Length

Art. No. Art. No.
Art. No. Art. No.

con cable de conexión
3 x 1,5²
with coiled supply
cable 3 x 1,5²

500 mm 01.721 01.727
1000 mm 01.722 01.728
2000 mm 01.723 01.729

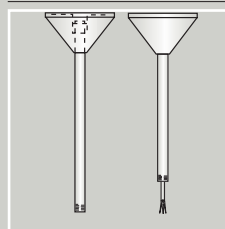

- + Para la fijación al techo, dosel blanco
- for ceiling mounting, suspension cover white

System 200

directa / indirecta
direct / indirect

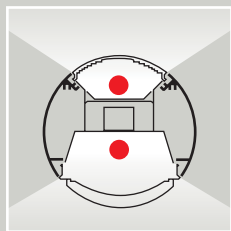

+ - 2 lámparas, balastro electrónico

- Módulo metálico blanco
- Bridas, cristal acrílico arriba
- Sin suspensión

- 2-lamps, electronic ballast

- White crossbar louvre
- Flange, acrylic diffuser above
- without suspension

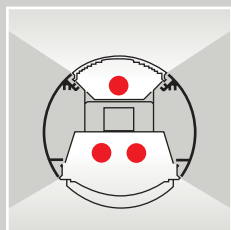

+ - 3 lámparas, balastro electrónico

- Módulo metálico blanco
- Bridas, cristal acrílico arriba
- Sin suspensión

- 3-lamps, electronic ballast

- White crossbar louvre
- Flange, acrylic diffuser above
- without suspension

directa / indirecta
direct / indirect

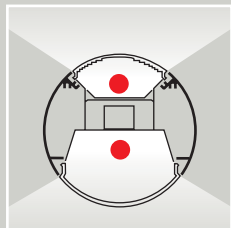

+ - 2 lámparas, balastro electrónico

- Vidrio acrílico
- Bridas
- Sin suspensión

- 2-lamps, electronic ballast

- Acrylic diffuser
- Flange
- without suspension

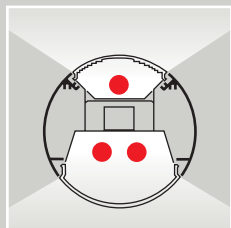

+ - 3 lámparas, balastro electrónico

- Vidrio acrílico
- Bridas
- Sin suspensión

- 3-lamps, electronic ballast

- Acrylic diffuser
- Flange
- without suspension

directa
direct

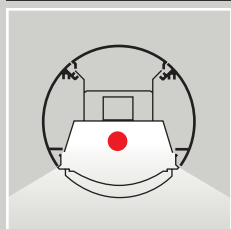

+ - 1 lámpara, balastro electrónico

- Módulo metálico blanco
- Bridas, cristal acrílico arriba
- Sin suspensión

- 1-lamp, electronic ballast

- White crossbar louvre
- Flange
- without suspension

Lámpara Lamp	Longitud Length	Art. No. Art. No.
2 x 36W T26	1333 mm	200.220
2 x 58W T26	1633 mm	200.221
2 x 2 x 36W T26	2660 mm	200.379
2 x 2 x 58W T26	3260 mm	200.380

Lámpara Lamp	Longitud Length	Art. No. Art. No.
3 x 36W T26	1333 mm	200.222
3 x 58W T26	1633 mm	200.223
2 x 3 x 36W T26	2660 mm	200.381
2 x 3 x 58W T26	3260 mm	200.382

Lámpara Lamp	Longitud Length	Art. No. Art. No.
2 x 36W T26	1333 mm	200.083
2 x 58W T26	1633 mm	200.084
2 x 2 x 36W T26	2660 mm	200.383
2 x 2 x 58W T26	3260 mm	200.384

Lámpara Lamp	Longitud Length	Art. No. Art. No.
3 x 36W T26	1333 mm	200.086
3 x 58W T26	1633 mm	200.087
2 x 3 x 36W T26	2660 mm	200.088
2 x 3 x 58W T26	3260 mm	200.089

Lámpara Lamp	Longitud Length	Art. No. Art. No.
1 x 36W T26	1333 mm	200.216
1 x 58W T26	1633 mm	200.217
2 x 1 x 36W T26	2660 mm	200.385
2 x 1 x 58W T26	3260 mm	200.386

System 200

directa direct

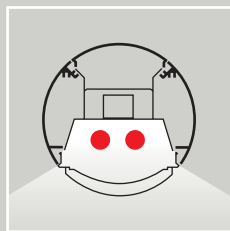

+ - 2 lámparas, balastro electrónico

- Módulo metálico blanco
- Bridas
- Sin suspensión

- 2-lamps, electronic ballast

- White crossbar louvre
- Flange
- without suspension

Lámpara Lamp	Longitud Length	Art. No. Art. No.
-----------------	--------------------	----------------------

2 x 36W T26	1333 mm	200.218
2 x 58W T26	1633 mm	200.219
2 x 2 x 36W T26	2660 mm	200.387
2 x 2 x 58W T26	3260 mm	200.388

directa direct

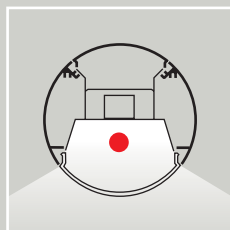

+ - 1 lámpara, balastro electrónico

- Vidrio acrílico
- Bridas
- Sin suspensión

- 1-lamp, electronic ballast

- Acrylic diffuser
- Flange
- without suspension

Lámpara Lamp	Longitud Length	Art. No. Art. No.
-----------------	--------------------	----------------------

1 x 36W T26	1333 mm	200.075
1 x 58W T26	1633 mm	200.076
2 x 1 x 36W T26	2660 mm	200.077
2 x 1 x 58W T26	3260 mm	200.078

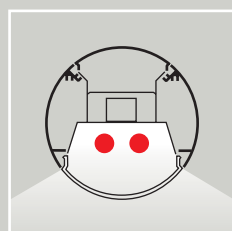

+ - 2 lámparas, balastro electrónico

- Vidrio acrílico
- Bridas
- Bridas

- 2-lamps, electronic ballast

- Acrylic diffuser
- Flange
- without suspension

Lámpara Lamp	Longitud Length	Art. No. Art. No.
-----------------	--------------------	----------------------

2 x 36W T26	1333 mm	200.079
2 x 58W T26	1633 mm	200.080
2 x 2 x 36W T26	2660 mm	200.081
2 x 2 x 58W T26	3260 mm	200.082

directa IP 55 direct IP 55

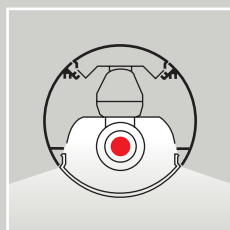

+ - 1 lámpara, balastro electrónico

- Vidrio acrílico
- Lacado para exterior
- Bridas
- Sin suspensión

- 1-lamp, electronic ballast

- Acrylic diffuser
- Painted for outdoor use
- Flange
- without suspension

Lámpara Lamp	Longitud Length	Art. No. Art. No.
-----------------	--------------------	----------------------

1 x 36W T26	1333 mm	200.090
1 x 58W T26	1633 mm	200.091
2 x 1 x 36W T26	2660 mm	200.092
2 x 1 x 58W T26	3260 mm	200.093

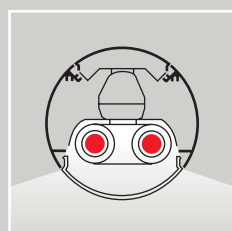

+ - 2 lámparas, balastro electrónico

- Vidrio acrílico
- Lacado para exterior
- Bridas
- Sin suspensión

- 2-lamps, electronic ballast

- Acrylic diffuser
- Painted for outdoor use
- Flange
- without suspension

Lámpara Lamp	Longitud Length	Art. No. Art. No.
-----------------	--------------------	----------------------

2 x 36W T26	1333 mm	200.094
2 x 58W T26	1633 mm	200.095
2 x 2 x 36W T26	2660 mm	200.096
2 x 2 x 58W T26	3260 mm	200.097

System 200

Cierre vidrio acrílico abajo para luminaria
Acrylic diffuser below for Lamp

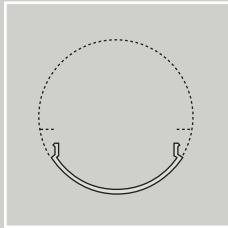

1 x 36W T26 **200.060**
 1 x 58W T26 **200.073**

- + - Con perfilado longitudinal
- with lengthwise prism

Placa terminal
End plate

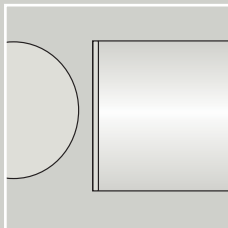

Placa terminal recta **200.068**
 Flat end plate

- + - Sin posibilidad de suspensión
- Suspension not possible

Perfil vacío
Empty tube

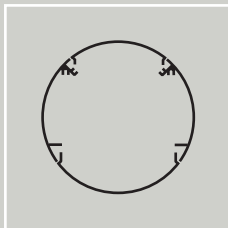

Perfil, de 4 piezas **200.389**
 4-part profile

- + - Alcance sin brida
- Length to be specified, without flange

Brazo extensor con pie
Wall bracket with adjustment

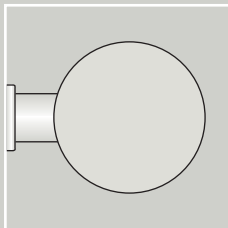

montaje en línea, abierto **200.371**
 two openings

montaje final, cerrado **200.370**
 one opening

- + - Alcance total 300 mm
- Total projection 300 mm

Cierre vidrio acrílico arriba para luminaria
Acrylic diffuser above for Lamp

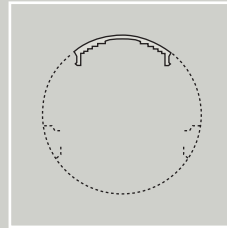

1 x 36W T26 **200.147**
 1 x 58W T26 **200.148**

- + - Con perfilado longitudinal
- with lengthwise prism

Elemento terminal
Tube end

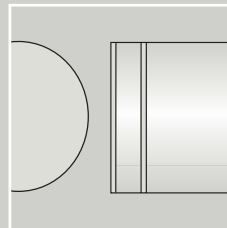

ø 200 x 45 mm **200.266**
 entrada de cables
 ø 200 x 45 mm
 cable entry hole

Empalme
Coupler

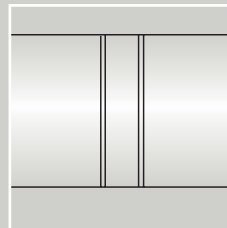

entrada de cables **200.067**
 Cable entry hole

- + - Rosca M4
- Suspension thread M4

System 200

Tubo oscilante Ø 13 mm Longitud **Art. No.** **Art. No.**
Rod suspension Ø 13 mm Length **Art. No.** **Art. No.**

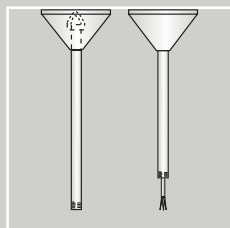

mit Zuleitung
 3 x 1,5²
 with coiled supply
 cable 3 x 1,5²

500 mm	01.709	01.715
1000 mm	01.710	01.716
2000 mm	01.711	01.717

- ⊢ - für Deckenhaken, Baldachin weiß
 - Suspension on ceiling hook, suspension cover, white

Cable en espiral **Art. No.**
Spiral cable **Art. No.**

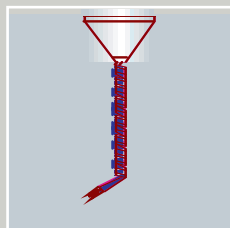

	Longitud Length	color Colour	Art. No.
	3 x 0,75 ² 250 - 800 mm	negro black	00.034
	3 x 0,75 ² 250 - 800 mm	blanco white	00.058
	3 x 1,5 ² 400 - 1200 mm	negro black	00.008

- ⊢ - Con dosel
 - with suspension cover

Balastro electrónico **Art. No.** **Art. No.**
Electronic ballast **Art. No.** **Art. No.**

		Art. No.	Art. No.
	(regulable) 5 - 100% técnica de control de 10 V (for dimming) Dimming 5 - 100% 10 V DC	Tren de ondas Control Phase control dimming	
⊢ - regulable 230 V 50 Hz incorporado y cableado	1 x 36W T26 09.366 1 x 58W T26 09.368 1 x 39W T16 09.526 1 x 49W T16 09.529 1 x 54W T16 09.530	00.641 00.642	
⊢ - Controllable ballast 230 V 50 Hz fitted and wired	1 x 80W T16 09.531		

Tubo oscilante Ø 13 mm Longitud **Art. No.** **Art. No.**
Rod suspension Ø 13 mm Length **Art. No.** **Art. No.**

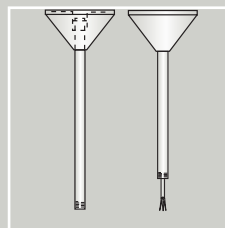

con cable de conexión
 3 x 1,5²
 with coiled supply
 cable 3 x 1,5²

500 mm	01.721	01.727
1000 mm	01.722	01.728
2000 mm	01.723	01.729

- ⊢ - Para gancho de techo, dosel blanco
 - for ceiling mounting, suspension cover white

Cable en espiral **Art. No.**
Spiral cable **Art. No.**

	longitud Length	color Colour	Art. No.
	3 x 1,5 ² 400 - 1200 mm	blanco white	00.057
	5 x 1,5 ² 400 - 1800 mm	negro black	00.009
	5 x 1,5 ² 400 - 1800 mm	blanco white	00.063

System 150 • 200

Medida de eje y puntos de suspensión
Dimensions & suspension points

Ø 150
Ø 150

Arco 90°
Bogen 90°

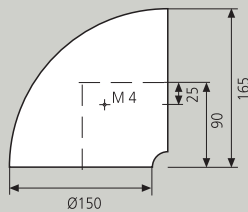

Arco 45°
Bogen 45°

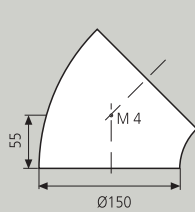

Conector en T
T-connector

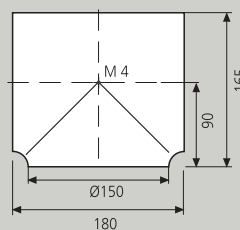

Conector en cruz
Cross connector

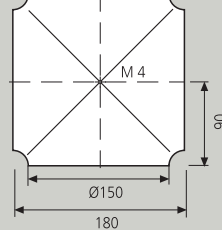

Brazo extensor
Wall bracket

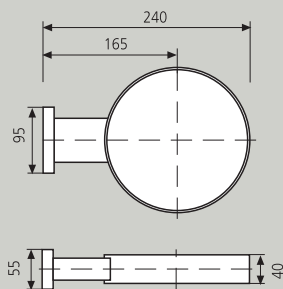

Empalme
Coupler

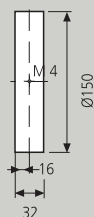

Elemento terminal
Tube end

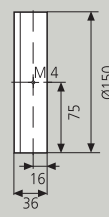

Medida de eje y puntos de suspensión
Dimensions & suspension points

Ø 200
Ø 200

Brazo extensor
Wall bracket

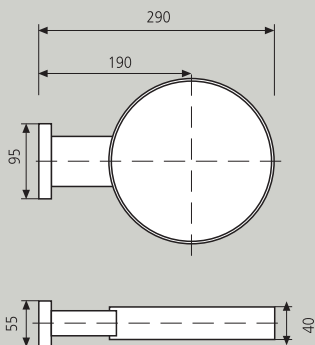

Empalme
Coupler

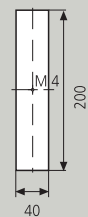

Elemento terminal
Tube end

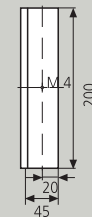

Colores
Colours

Nombre
Name

RAL

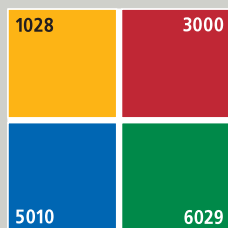

1028	3000	amarillo melón melon yellow	1028
		rojo fuego fire red	3000
5010	6029	azul blue	5010
		verde menta mint green	6029

Colores
Colours

Nombre
Name

RAL

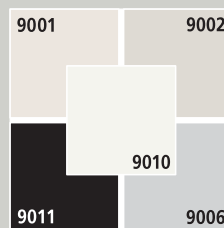

9001	9002	blanco crema creme white	9001
		blanco grisáceo grey white	9002
	9010	blanco puro pure white	9010
9011	9006	negro grafito graphite black	9011
		plata silver	9006

☞ Consulte posibilidad de suministro en otros colores
Other colours available on request

☞ Consulte posibilidad de suministro en otros colores
Other colours available on request

System 100

