

System 70 71 72 Lightline

Modelos / Models



System

70 • 71 • 72

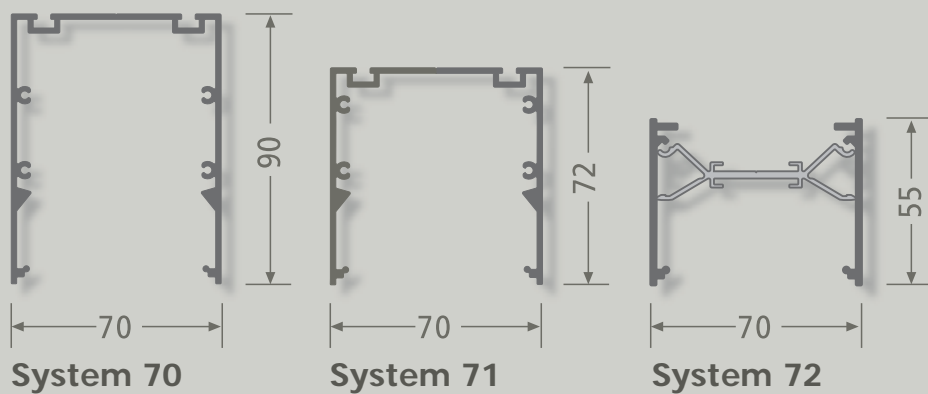

- Un sistema de luminarias con tres posibles perfiles para todo tipo de variantes.

- Pequeñas dimensiones.

- Las luminarias suspendidas o empotradas han sido desarrolladas para las nuevas lámparas fluorescentes Ø 16 (T5).

- Es posible integrar sin problemas módulos adicionales de la técnica de edificios o doméstica.

- Respetamos el medio ambiente empleando materiales reciclables.

- Un diseño moderno y agudo.

- Perfiles de aluminio.

- Adaptación longitudinal para cualquier trama constructiva individual.

- Luminarias con balastos electrónicos.

- Espejos reflectores

- Cableado pasante de 3 polos 1,5².

- Luminaire system with three profile variations for diversely creative possibilities.

- Small sized.

- Suspended or built-in luminaires have been developed for the new 16 mm dia. fluorescent lamps.

- Supplementary building technology (HVAC) modules can be integrated without problem.

- Modern, sharp-edged design.

- Profiled aluminium.

- Luminaires with electronic ballasts.

- Mirror reflectors.

- Lengths fitted to all building specifications.

- 3 pole through-wiring 1,5².

System 70

Directa, perfil 70 x 90 mm
direct, pre-formed structure 70 x 90 mm

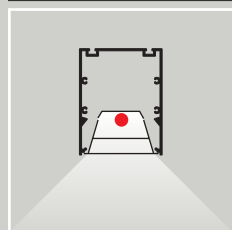

+ - 1 lámpara, balastro electrónico

- Reflector parabólico
- Luminaria sin placas terminales
- Sin suspensión

- 1-lamp, electronic ballast

- Parabolic reflector
- Luminaire without endplates
- without suspension

Lámpara Lamp	Longitud Length	Art. No. Art. No.
1 x 39W T16	1022 mm	70.103314
1 x 49W T16	1622 mm	70.103315
1 x 54W T16	1322 mm	70.103316
1 x 80W T16	1622 mm	70.103317

Directa, perfil 70 x 90 mm
direct, pre-formed structure 70 x 90 mm

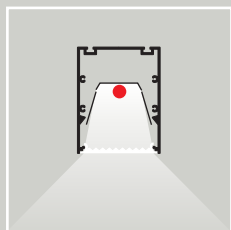

+ - 1 lámpara, balastro electrónico

- Vidrio acrílico satinado
- Luminaria sin placas terminales
- Sin suspensión

- 1-lamp, electronic ballast

- Acrylic diffuser, satiné
- Luminaire without endplates
- without suspension

Lámpara Lamp	Longitud Length	Art. No. Art. No.
1 x 39W T16	1022 mm	70.103319
1 x 49W T16	1622 mm	70.103320
1 x 54W T16	1322 mm	70.103321
1 x 80W T16	1622 mm	70.103322

Perfil vacío, 70 x 90 mm
Empty pre-formed structure 70 x 90 mm

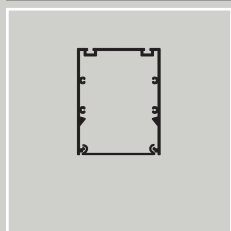

+ - Perfil vacío con cierre

- Empty pre-formed structure including cover

Bestellnr.
Art. No.

70.103323

+ - Longitud según especificación
- Length to be specified



System 70

Placa terminal End plate

Art. No.
Art. No.

70.103325

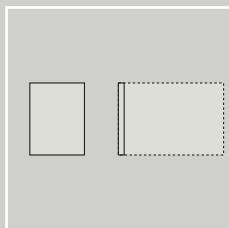

Empalme para disposición en línea Coupler for band assembly

Art. No.
Art. No.

70.103326

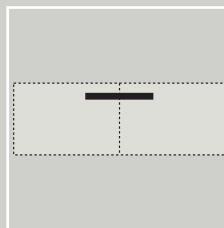

Portalámparas Holders

Art. No.
Art. No.

E 14 70.103327

GU 5, 3 70.103328

G4 70.103329

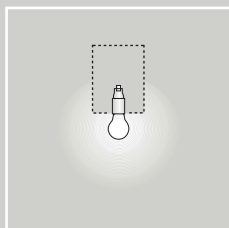

Conector de inglete Corner Connector

Águlo
Angle

Art. No.
Art. No.

30° 70.103332

45° 70.103333

60° 70.103334

90° 70.103335

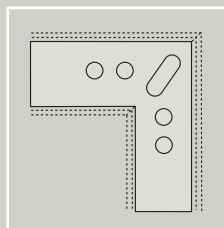

- + - Conector de chapa de acero, incluidas secciones transversales
- Grooved sheet-steel connector

Suspensión cable acero en Y Steel wire Y-suspension

Longitud
Length

Art. No.
Art. No.

Ajuste rápido sin
necesidad de herramientas
tool-less
adjustable

500 mm 01.103080

1000 mm 01.103081

2000 mm 01.103082

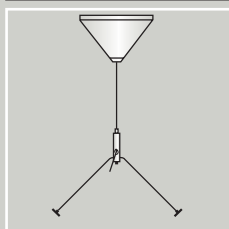

- + - Para gancho de techo, dosel blanco
- Suspension on ceiling hook, suspension cover white

Suspensión cable acero en Y Steel wire Y-suspension

Longitud
Length

Art. No.
Art. No.

Ajuste rápido sin
necesidad de herramientas
tool-less
adjustable

500 mm 01.103083

1000 mm 01.103084

2000 mm 01.103085

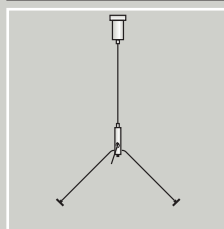

- + - Fijación al techo, blanca
- Suspension on ceiling, white

System 71

Directa, perfil 70 x 72 mm
direct, pre-formed structure 70 x 72 mm

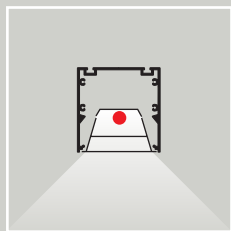

+ - 1 lámpara, balastro electrónico

- Reflector parabólico
- Luminarias sin placas terminales
- Sin suspensión

- 1-lamp, electronic ballast

- Parabolic reflector
- Luminaire without endplates
- without suspension

Lámpara Lamp	Longitud Length	Art. No. Art. No.
1 x 39W T16	1022 mm	71.103337
1 x 49W T16	1622 mm	71.103338
1 x 54W T16	1322 mm	71.103339
1 x 80W T16	1622 mm	71.103340

Directa, perfil 70 x 72 mm
direct, pre-formed structure 70 x 72 mm

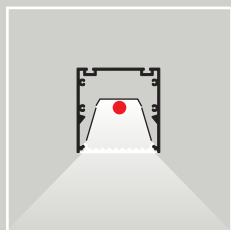

+ - 1 lámpara, balastro electrónico

- Vidrio acrílico satinado
- Luminarias sin placas terminales
- Sin suspensión

- 1-lamp, electronic ballast

- Acrylic diffuser, Satine
- Luminaire without endplates
- without suspension

Lámpara Lamp	Longitud Length	Art. No. Art. No.
1 x 39W T16	1022 mm	71.103342
1 x 49W T16	1622 mm	71.103343
1 x 54W T16	1322 mm	71.103344
1 x 80W T16	1622 mm	71.103345

Directa, perfil 70 x 72 mm
direct, pre-formed structure 70 x 72 mm

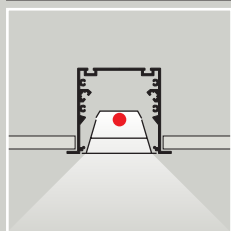

+ - 1 lámpara, balastro electrónico

- Reflector parabólico
- Luminarias sin placas terminales
- Montaje empotrado

- 1-lamp, electronic ballast

- Parabolic reflector
- Luminaire without end plates
- Recessed construction

Lámpara Lamp	Longitud Length	Art. No. Art. No.
1 x 39W T16	1022 mm	71.103348
1 x 49W T16	1622 mm	71.103349
1 x 54W T16	1322 mm	71.103350
1 x 80W T16	1622 mm	71.103351

Directa, perfil 70 x 72 mm
direct, pre-formed structure 70 x 72 mm

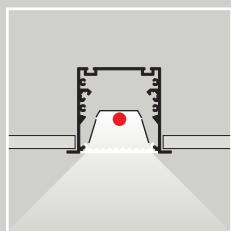

+ - 1 lámpara, balastro electrónico

- Vidrio acrílico satinado
- Luminarias sin placas terminales
- Montaje empotrado

- 1-lamp, electronic ballast

- Acrylic diffuser, Satine
- Luminaire without end plates
- Recessed construction

Lámpara Lamp	Longitud Length	Art. No. Art. No.
1 x 39W T16	1022 mm	71.103353
1 x 49W T16	1622 mm	71.103354
1 x 54W T16	1322 mm	71.103355
1 x 80W T16	1622 mm	71.103356



System 71

Perfil vacío, 70 x 72 mm Empty pre-formed structure 70 x 72 mm

Art. No.
Art. No.

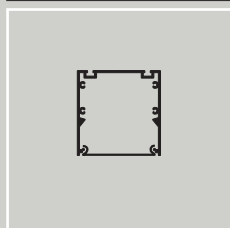

- Perfil vacío con cierre
- Empty pre-formed structure including cover profile

71.103357

Perfil vacío, 70 x 72 mm Empty pre-formed structure 70 x 72 mm

Art. No.
Art. No.

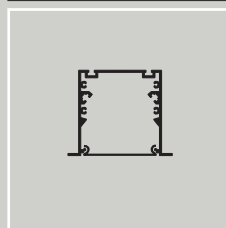

- Perfil vacío con cierre
- Montaje empotrado
- Empty pre-formed structure including cover profile
- Recessed construction

71.103358

Placa terminal, 70 x 72 mm End plate, 70 x 72 mm

Art. No.
Art. No.

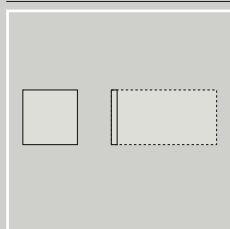

71.103359

Placa terminal, 70 x 72 mm End plate, 70 x 72 mm

Art. No.
Art. No.

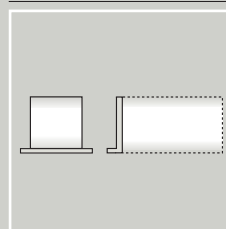

- Montaje empotrado
- Recessed construction

71.103360

Conector de inglete Corner Connector

Ángulo
Angle

Art. No.
Art. No.

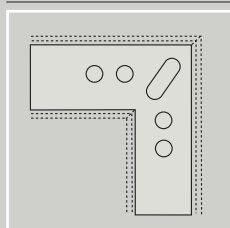

- 30° 71.103369
- 45° 71.103370
- 60° 71.103371
- 90° 71.103372

- + - Conector de chapa de acero, incluidas secciones transversales
- Grooved sheet-steel connector

Juego de montaje Fixing kit

Art. No.
Art. No.

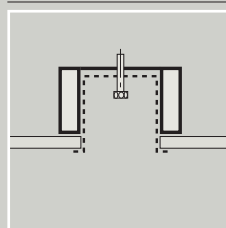

- 1 par de fallebas
- 1 Set brackets

71.103377

Portalámparas Holders

Art. No.
Art. No.

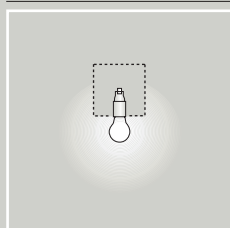

- E 14 71.103361
- GU 5, 3 71.103362
- G4 71.103363

Empalme para disposición en línea Coupler for band assembly

Art. No.
Art. No.

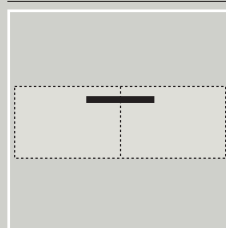

70.103326

Suspensión cable acero en Y Steel wire Y-suspension

Longitud
Length

Art. No.
Art. No.

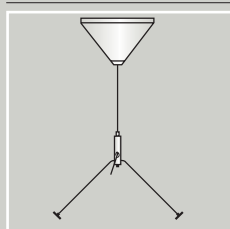

- Ajuste rápido sin necesidad de herramientas
tool-less adjustable
- 500 mm 01.103080
 - 1000 mm 01.103081
 - 2000 mm 01.103082

- + - Ajuste rápido sin necesidad de herramientas
- Suspension on ceiling hook, suspension cover white

Suspensión cable acero en Y Steel wire Y-suspension

Longitud
Length

Art. No.
Art. No.

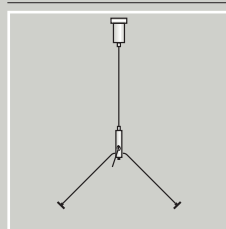

- Ajuste rápido sin necesidad de herramientas
tool-less adjustable
- 500 mm 01.103083
 - 1000 mm 01.103084
 - 2000 mm 01.103085

- + - Fijación al techo, blanca
- Suspension on ceiling, white

System 72



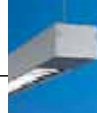

System 72

Luminaria suspendida directa/indirecta 70 x 55 mm Suspended luminaire direct/indirect, 70 x 55 mm

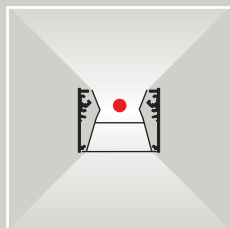

⚡ - 1 lámpara, balastro electrónico

- Reflector parabólico mate
- Suspensión de cable de acero

1-lamp, electronic ballast

- Parabolic reflector, mat
- Steel wire suspension

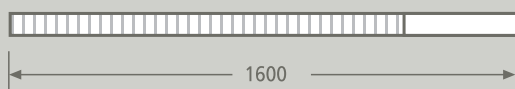

1 x 54W T16 (T5)

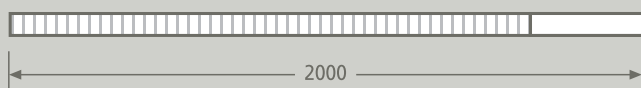

1 x 49W T16 (T5) / 1 x 80W T16 (T5)

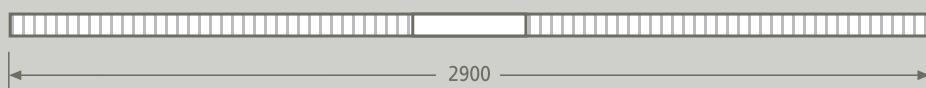

2 x 1 x 54W T16 (T5)



Lámpara Lamp	Longitud Length	Art. No. Art. No.
1 x 54W T16	1600 mm	72.103378
1 x 49W T16	2000 mm	72.103379
1 x 80W T16	2000 mm	72.103380
2 x 1 x 54W T16	2900 mm	72.103381

- Un sistema de luminarias de dimensiones mínimas. Podemos cumplir todas las exigencias de los arquitectos de interiores, arquitectos e ingenieros.

- Las luminarias suspendidas para lámparas fluorescentes Ø 16 (T5) permiten multitud variaciones en interiores.

- Luminarias de aluminio y acero de gran rentabilidad enfocadas al diseño.

- Respetamos el medio ambiente con un menor consumo de material.

- Luminarias con balastro electrónico.

- Posibilidad de incorporar componentes para sistemas de control de luz o detectores de presencia.

- A compact luminaire system to satisfy the demands of interior designers, architects and engineers.

- The luminaire modules for the fluorescent lamps T5 (Ø 16 mm) allow virtually unlimited design possibilities.

- Manufactured from aluminium and steel.

- Luminaire including electronic ballast.

- Environmentally friendly through less material.

- Alternative built-in systems; lighting control components or presence-detection sensors.

- VDU reflector aluminium.